

**2021
INTERIOR
FIT-OUT
EVOLUTION**

**DEMOUNTABLE
PARTITIONS
SYSTEMS**

PARETI MOBILI

RAISED ACCESS FLOORS
METAL CEILINGS & COVERINGS
WOOD CEILINGS & COVERINGS
DEMOUNTABLE PARTITIONS
SUSPENSION SYSTEMS
INTEGRATED AIR CONDITIONING SYSTEMS
OFFICE FURNITURE SYSTEMS

INTERIOR FIT-OUT EVOLUTION

Hi-tech interior products of the new generation.

CBI Europe has produced technological and innovative systems for a complete interior installation, with passion and precision, for thirty-five years, worldwide.

The technical experience and the continuous comparison, with the demands of designers from different markets, make CBI EUROPE an ideal reference point for those who design new, refined and comfortable interiors, and at the same time CBI EUROPE is technologically advanced in an integrated context, offering a very wide range of systems, products, materials, technical solutions and alternatives that improve work environments of the latest generation. We are committed to creating healthy and socially responsible environments. With our continuous research of new materials and systems, the international competition and comparison, awareness of needing to evolve the dynamics of modern construction techniques and to solve traditional problems. CBI Europe says today, these methods; technique, creativity and Italian style promote an interior of the third millennium, worldwide.

**The future is to ensure the quality of the environment
in which we live.**

Prodotti hi-tech per interni di nuova generazione.

CBI Europe produce con passione e precisione sistemi innovativi e tecnologici per l'allestimento completo d'interni, da oltre trentacinque in tutto il mondo.

L'esperienza tecnica maturata e il confronto continuo con le esigenze di progettisti di diversi mercati fanno di CBI EUROPE un riferimento unico ideale per chi progetta interni nuovi, ricercati, confortevoli e al tempo stesso tecnologicamente avanzati in ottica integrata, proponendo una gamma molto ampia di sistemi, prodotti, materiali e soluzioni tecniche alternative e migliorative per ambienti di ultima generazione.

Impegno per la creazione di ambienti sani e socialmente responsabili, ricerca continua di materiali e nuovi sistemi, competizione e confronto internazionale, consapevolezza dell'esigenza di evolvere le dinamiche delle moderne tecniche costruttive per risolvere le problematiche tradizionali sono i metodi con cui CBI Europe, oggi, afferma la tecnica, la creatività e lo stile italiano nel mondo e promuove un'edilizia per interni di terzo millennio.

Il futuro é garantire la qualità degli interni in cui viviamo.



The future is now: CBI Europe integrated solutions for high-quality environments.

**Technological
and innovative
systems
for a complete
interior
installation,
with passion
and precision,
for 35 years,
worldwide.**

Reliable and timely deliveries all around the world
Consegne puntuali e affidabili in tutto il mondo

CBI EUROPE, IN THE HEART OF ITALY

Thanks to its strategic location in central Italy, in the heart of the Mediterranean region, CBI Europe is the ideal partner for Middle Eastern, African, Central and Eastern European customers.

La posizione dell'azienda nel centro Italia, nel cuore della produzione mediterranea, fa di CBI Europe il partner ideale per clienti in Medio Oriente, Africa, Centro e mercati dell'Europa orientale.





Our partition systems' versatility of design and composition allows free separation of contemporary architectural spaces.

Demountable partitions, integrated solutions for high-quality work environments.

Ease of set-up and versatility characterize CBI Europe's partition walls. Designed to adapt to any type of environment thanks to the wide range of modules and available finishes, standard or customized, they are the hi-tech solution for the management of functional and comfortable space.

WHERE Living spaces and workspaces.

HOW Solutions in glass, wood and metal, simple, fast, guaranteed and certified.

WHY Our professional and prepared technical department guarantees maximum assistance in terms of cost and design.

Pareti mobili, soluzioni hi-tech integrate per ambienti di lavoro di alta qualità.

Facilità di allestimento e versatilità caratterizzano le pareti divisorie CBI Europe. Progettate per adattarsi a qualsiasi tipo di ambiente grazie all'ampia gamma di moduli e finiture disponibili, standard o su misura, sono la soluzione hi-tech per la gestione dello spazio funzionale e confortevole.

DOVE Ambienti di vita e spazi di lavoro.

COME Soluzioni in vetro, legno e metallo, semplici, veloci, garantite e certificate.

PERCHÉ Il nostro ufficio tecnico, professionale e preparato, garantisce la massima assistenza in termini di costo e progettazione.

**Our projects
are always
'custom-made':
speed,
versatility,
quality,
satisfaction.**

PARTITION SYSTEMS



Ghost One - Two



Infinity 90



Genesy



Iron Genesy



Wall System



Flexwall



IDEAL FOR
offices - open space - meeting rooms

GHOST ONE - GHOST TWO

Brightness and minimal design

Luminosità e design minimale

Current Business Welfare Strategies decline in architectural choices and the principle of transparency also applies to defining spaces.

Bright, transparent offices and environments, divided by large windows with the monolithic and minimal GHOST system, are a must for the consciousness of contemporary design which is focused on comfort.

Available versions:

GHOST ONE: single glass.

GHOST TWO: double glass.

Le attuali strategie di Welfare aziendale si declinano nelle scelte architettoniche, e il principio della trasparenza vige anche nella definizione degli spazi.

Uffici e ambienti trasparenti, luminosi, divisi da ampie vetrate con il sistema GHOST, monolitico e minimale, sono un must della consapevolezza progettuale contemporanea concentrata su comfort e qualità degli interni.

Versioni disponibili:

GHOST ONE: vetro singolo.

GHOST TWO: doppio vetro.



LIGHTNING
ILLUMINAZIONE



QUICK INSTALLATION
INSTALLAZIONE RAPIDA



ACOUSTIC ABSORPTION
FONOASSORBENZA



LIGHT WEIGHT
LEGGEREZZA



GHOST ONE - satin glass sticker Galil Medical - Boston Scientific BTG Group Offices - Israel



Illumination and transparency in the work environment. Minimal impact partition.

*Luminosità e trasparenza degli ambienti.
 Minimalismo dell'impatto divisorio*

GHOST ONE - satin glass sticker
 Galil Medical - Boston Scientific BTG Group Offices
 Israel

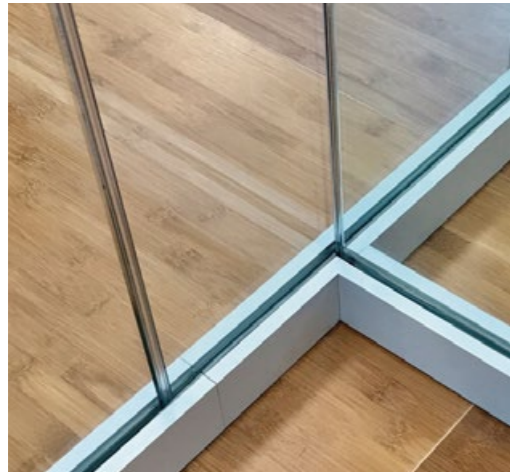

RTF 3 way joint
Raccordo a tre vie RTF

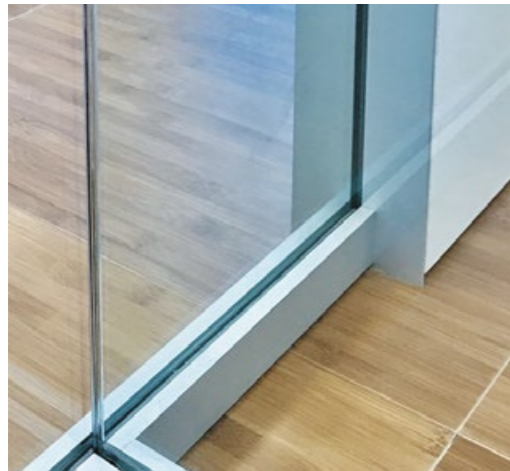

Glass module/blind module junction
Raccordo modulo vetrato/modulo cieco



RTF 90 degree corner
Angolo completo 90° RTF





GHOST ONE
Cenerelli Offices _ Osimo, Italy

GHOST ONE

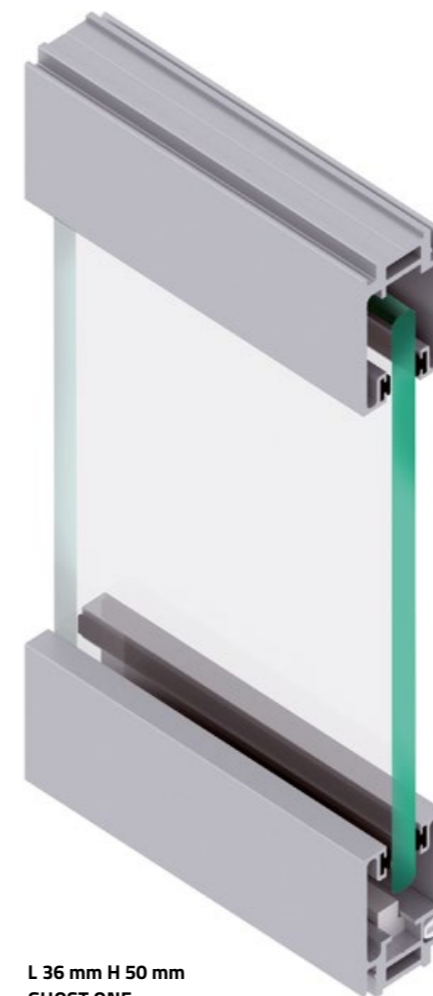

L 36 mm H 50 mm
GHOST ONE
single glass
vetro singolo

GHOST TWO

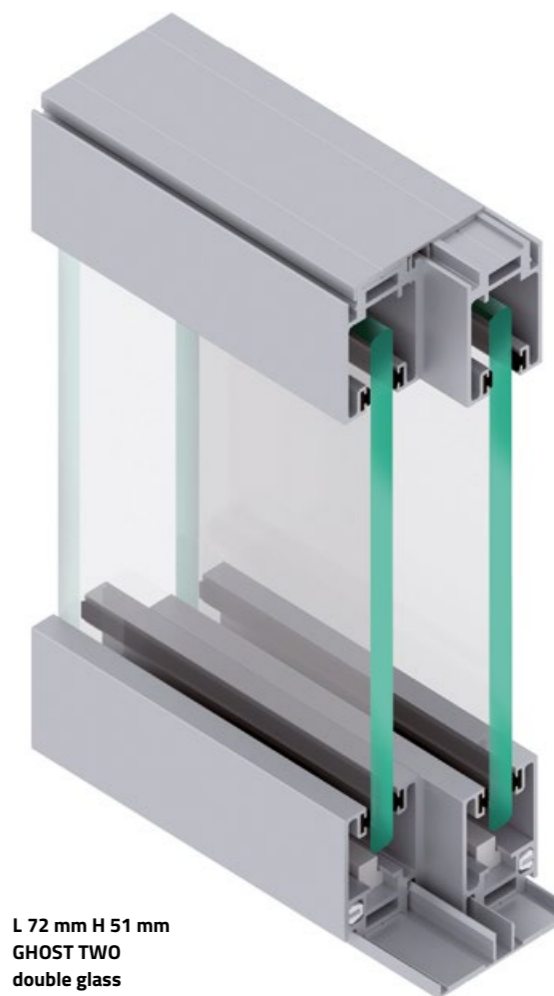

L 72 mm H 51 mm
GHOST TWO
double glass
doppio vetro

ACOUSTIC ABSORPTION FONOASSORBENZA



10 mm laminated glass airborne sound insulation · isolamento al rumore aereo diretto con vetro stratificato 10 mm

glass type tipologia vetro	laminated glass 55.1 vetro stratificato 55.1	laminated glass 55.1 with acoustic PVB vetro stratificato 55.1 con PVB acustico	laminated glass 55.2 vetro stratificato 55.2	laminated glass 55.2 with acoustic PVB vetro stratificato 55.2 con PVB acustico
dB value valore dB	35 dB	38 dB	35 dB	39 dB
glass weight peso vetro	25 kg/m ²	25 kg/m ²	26 kg/m ²	26 kg/m ²

12 mm laminated glass airborne sound insulation · isolamento al rumore aereo diretto con vetro stratificato 12 mm

glass type tipologia vetro	laminated glass 66.1 vetro stratificato 66.1	laminated glass 66.1 with acoustic PVB vetro stratificato 66.1 con PVB acustico	laminated glass 66.2 vetro stratificato 66.2	laminated glass 66.2 with acoustic PVB vetro stratificato 66.2 con PVB acustico
dB value valore dB	36 dB	40 dB	36 dB	40 dB
glass weight peso vetro	30 kg/m ²	30 kg/m ²	31 kg/m ²	31 kg/m ²

*glass certification available under request at project dept. of CBI Europe · certificato vetro su richiesta all'ufficio progettazione CBI Europe

STRUCTURES STRUTTURE

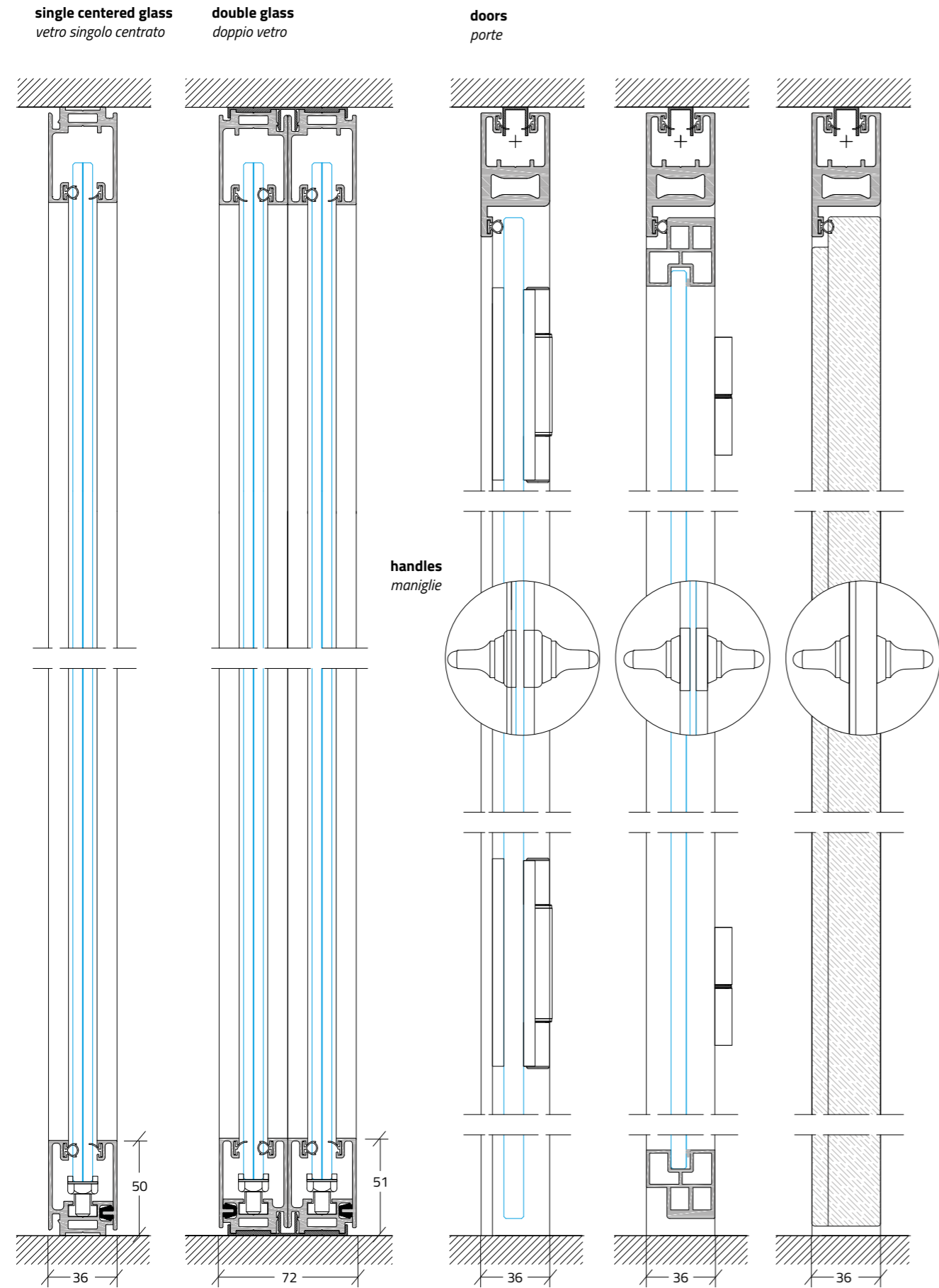

ACCESSORIES ACCESSORI

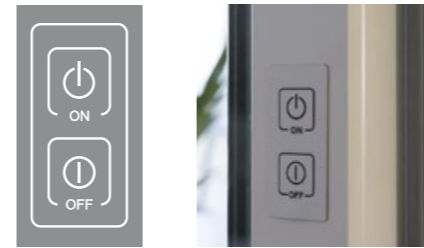

Lightening button thickness 1 mm. Its flexible and adhesive construction allows the application on all surfaces, curved also. It can be fixed on the upright of the door at any height.

Interruttore di spessore 1 mm, flessibile, si può applicare su tutte le superfici, anche curve. Può inoltre essere fissato sul montante della porta a qualsiasi altezza grazie alla pellicola adesiva 3M.

JOINT GIUNZIONI

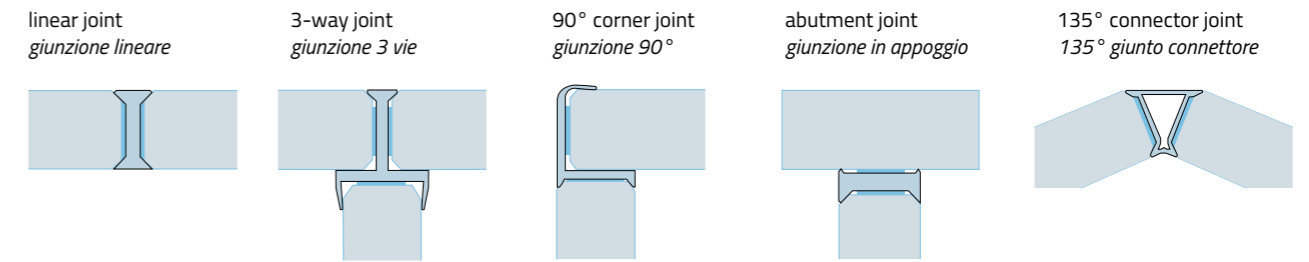

The glass is secured using structural transparent bi-adhesive silicone or through vertical transparent polycarbonate joints, which ensure the coplanarity. Stability and acoustics are further guaranteed by a series of soft extruded seals in PVC, located along the perimeter, securing the glass.

I vetri sono collegati tramite biadesivo silconico strutturale trasparente o tramite giunti verticali in policarbonato trasparente che ne garantiscono la coplanarità. Stabilità e tenuta acustica sono garantite da guarnizioni estruse in PVC morbido, collocate lungo i profili perimetrali, fermavetro.

AVAILABLE COLOR FOR STRUCTURE COLORI DISPONIBILI STRUTTURE



AVAILABLE FINISHINGS FOR GLASS FINITURE DISPONIBILI VETRO

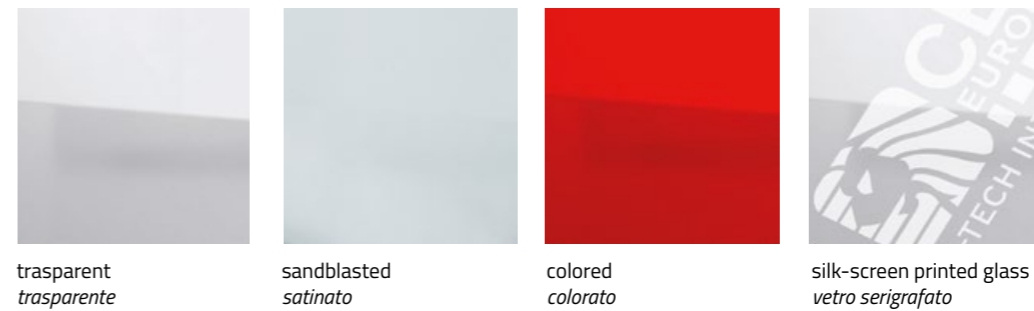



IDEAL FOR

offices · open space · meeting rooms

INFINITY 90



One product, endless possibilities

Una parete, infinite possibilità

Infinity 90 make the environments modern and bright. Solutions with a functional design, of the highest quality and consistency. The technology developed for this product works at aesthetics service and the structural points remain hidden under decorative surfaces.

Available versions:

single glass · double glass · triple glass

Infinity 90 rende gli ambienti moderni e luminosi. Soluzioni dal design funzionale, della massima qualità e coerenza. La tecnologia sviluppata per questo prodotto nasce al servizio dell'estetica, grazie ai punti strutturali che rimangono nascosti sotto le superfici decorative.

Versioni disponibili:

vetro singolo · vetro doppio · vetro triplo



LIGHTNING
ILLUMINAZIONE



QUICK INSTALLATION
INSTALLAZIONE RAPIDA



ACOUSTIC ABSORPTION
FONOASSORBENZA



LIGHT WEIGHT
LEGGEREZZA



INFINITY 90 DOUBLE GLASS UCC Tower · Losail, Qatar



INFINITY 90 DOUBLE GLASS
Qatar Gas Tower - Doha, Qatar

INFINITY 90

INFINITY 90 SINGLE GLASS
UCC Tower - Losail, Qatar

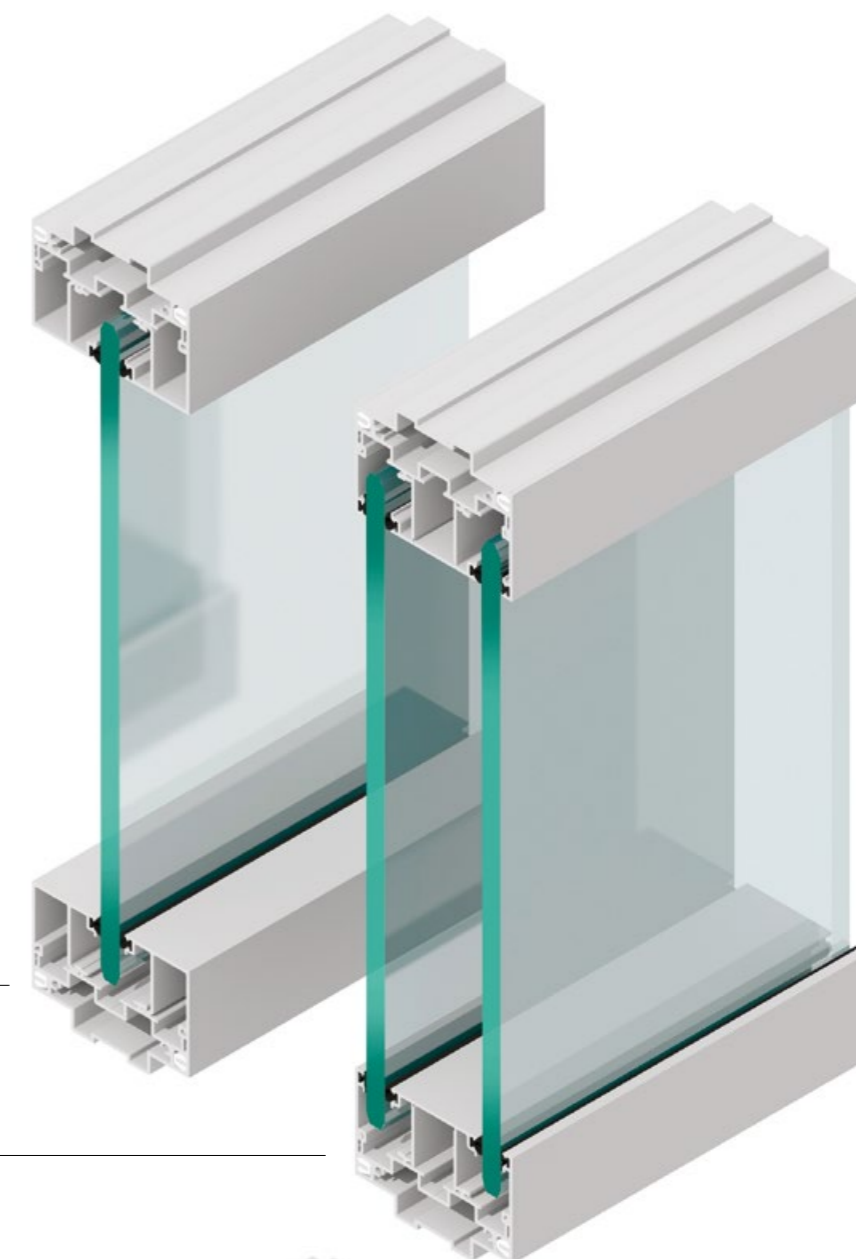

L 90 mm H 63 mm
single centered glass
vetro singolo centrato
10 mm / 12 mm stratified glass
(5 + 0.38 + 5) (6 + 0.38/0.76 + 6)

L 90 mm H 63 mm
double glass *doppio vetro*
10 mm / 12 mm stratified glass
(5 + 0.38 + 5) (6 + 0.38/0.76 + 6)

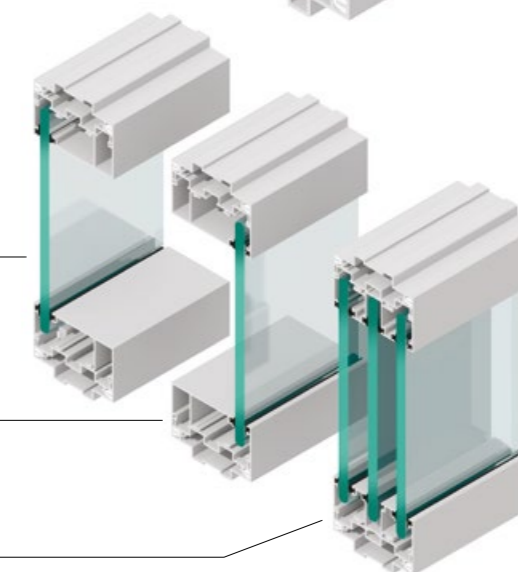

L 90 mm H 63 mm
single decentered interior glass
vetro singolo decentrato interno
10 mm / 12 mm stratified glass
(5 + 0.38 + 5) (6 + 0.38/0.76 + 6)

L 90 mm H 63 mm
single decentered exterior glass
vetro singolo decentrato esterno
10 mm / 12 mm stratified glass
(5 + 0.38 + 5) (6 + 0.38/0.76 + 6)

L 90 mm H 63 mm
triple glass *triplo vetro*
10 mm / 12 mm stratified glass
(5 + 0.38 + 5) (6 + 0.38/0.76 + 6)

STRUCTURES STRUTTURA

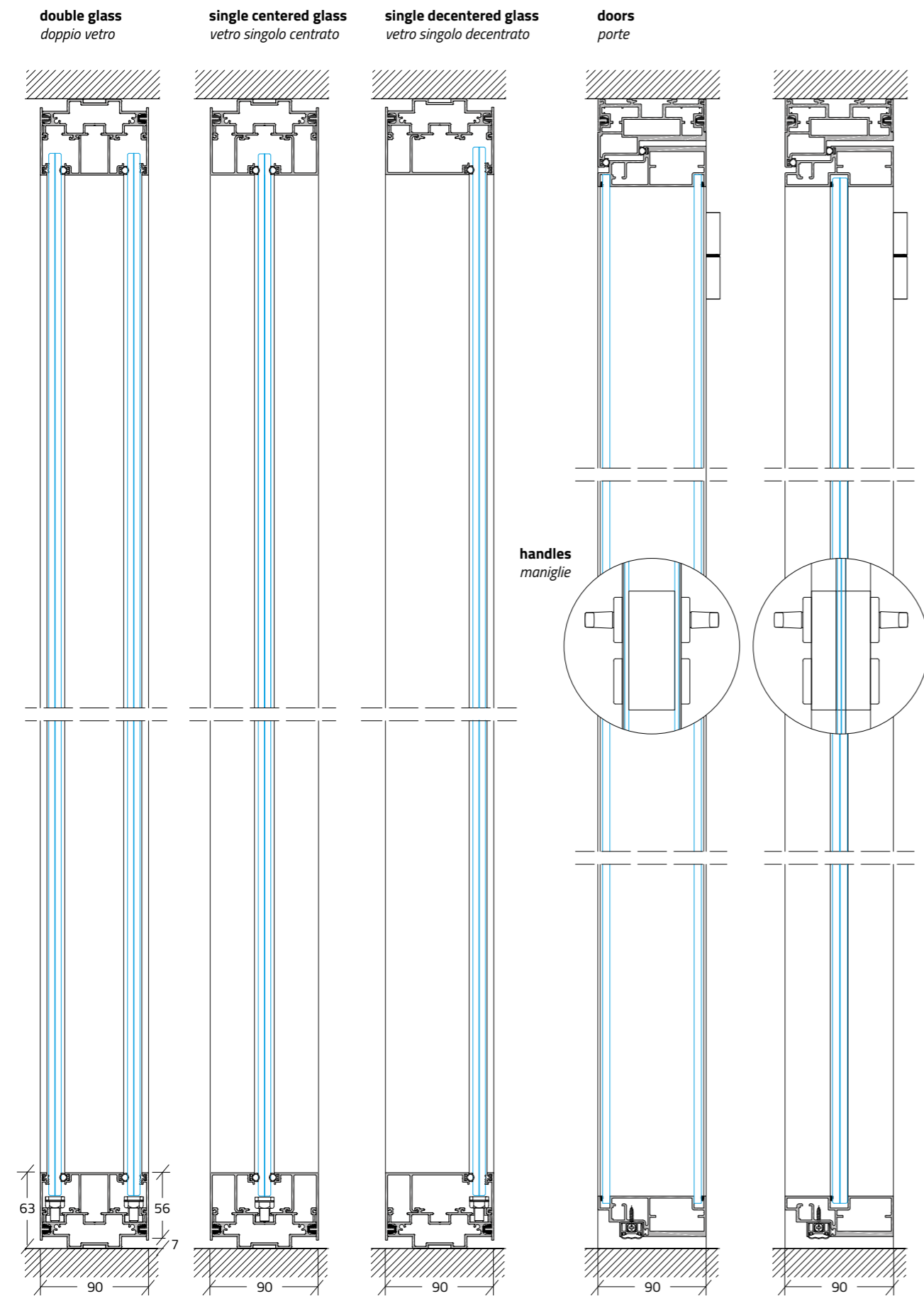

ACOUSTIC ABSORPTION FONASSORBENZA

			sound insulation values fonoassorbenza
glass partition pareti vetrate	single glazed vetro singolo	10 mm 5 + 0,38 + 5 mm	Rw 35 dB
		12 mm 6 + 0,76 + 6 mm	Rw 39 dB
	double glazed vetro doppio	10 mm 5 + 0,38 + 5 mm	Rw 41 dB
		12 mm 6 + 0,76 + 6 mm	Rw 44 dB
solid partition pannelli ciechi	melamine faced panel rivestimento melaminico	16 mm	Rw 42 dB
hinged doors porte a battente	single framed door, double glazed anta singola intelaiata, vetro doppio	6 mm	Rw 37 dB
	single framed door, single glazed anta singola intelaiata, vetro singolo	12 mm	Rw 37 dB
	single frameless door, single glazed anta singola senza telaio, vetro singolo	12 mm	Rw 28 dB
	single solid hinged door anta singola, pannello cieco	standard	Rw 24 dB
	single solid hinged door anta singola, pannello cieco	acoustic · fonoassorbente	-

CERTIFICATIONS CERTIFICAZIONI

HORIZONTAL LOAD CERTIFICATION · CERTIFICAZIONE DI CARICO ORIZZONTALE		according to standards UNI 108779: 2000
single glass partition · parete vetro singolo		compliant · conforme
double glass partition · parete doppio vetro		compliant · conforme
solid partition · parete cieca		compliant · conforme

*partition certification available under request at project dept. of CBI Europe · certificato pareti su richiesta all'ufficio progettazione CBI Europe

AVAILABLE COLOR FOR STRUCTURE COLORI DISPONIBILI STRUTTURE



AVAILABLE FINISHINGS FOR GLASS FINITURE DISPONIBILI VETRO

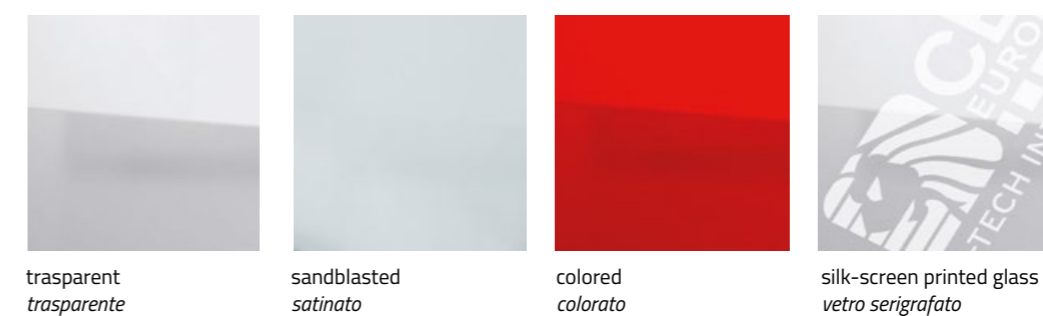



Liberty of design and composition, thanks to the variety of joining elements, makes it possible to be created with the possibility of creating non-orthogonal walls. Environments can be configured - and reconfigured - with no space constraints.

La libertà progettuale e di composizione, grazie alla varietà degli elementi di raccordo, si realizza anche con la possibilità di creare pareti non ortogonali. Gli ambienti possono essere configurati e riconfigurati senza vincoli di spazio.

IDEAL FOR

offices - open space - meeting rooms

GENESY

Stability, privacy, safety Stabilità, privacy, sicurezza

In harmony with the different design ideas and the aesthetics, the technical and functional requirements, and its modularity, the GENESY system allows the organization of a space in a contemporary, elegant and confidential way.

Glazed, blind, available in a wide range of wood or color finishes, GENESY modules are easy to install and designed to ensure maximum stability, durability, safety, acoustics and hygiene.

In accordo con le diverse idee progettuali e le esigenze estetiche, tecniche e funzionali, il sistema GENESY, componibile e modulare, permette di organizzare uno spazio in modo contemporaneo, elegante e riservato.

Vetrati o ciechi, disponibili in un'ampia gamma di finiture in legno o colori, i moduli GENESY sono facili da installare e studiati per garantire il massimo delle prestazioni di stabilità, durata, sicurezza, acustica ed igiene.



QUICK INSTALLATION
INSTALLAZIONE RAPIDA



ACOUSTIC ABSORPTION
FONOASSORBENZA



HYGIENE & CLEANING
IGIENE & PULIZIA



EXTENDED WORKING LIFE
DURABILITÀ



GENESY STG Creation · Precigems, Switzerland

DEMOUNTABLE PARTITIONS



Venetian blind with knob (tilt and turn function)
Tendina veneziana con pomolo (solo orientamento)

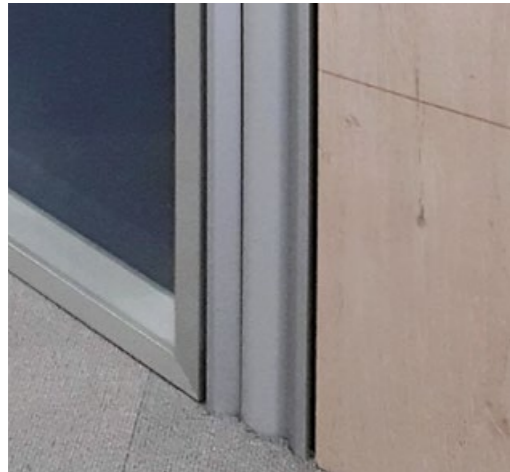

3 way joint
Raccordo a tre vie



90° corner
Angolo 90°

GENESY
Aston Building head quarters - Košice, Slovakia



GENESY

↑
H MAX 4000 MM

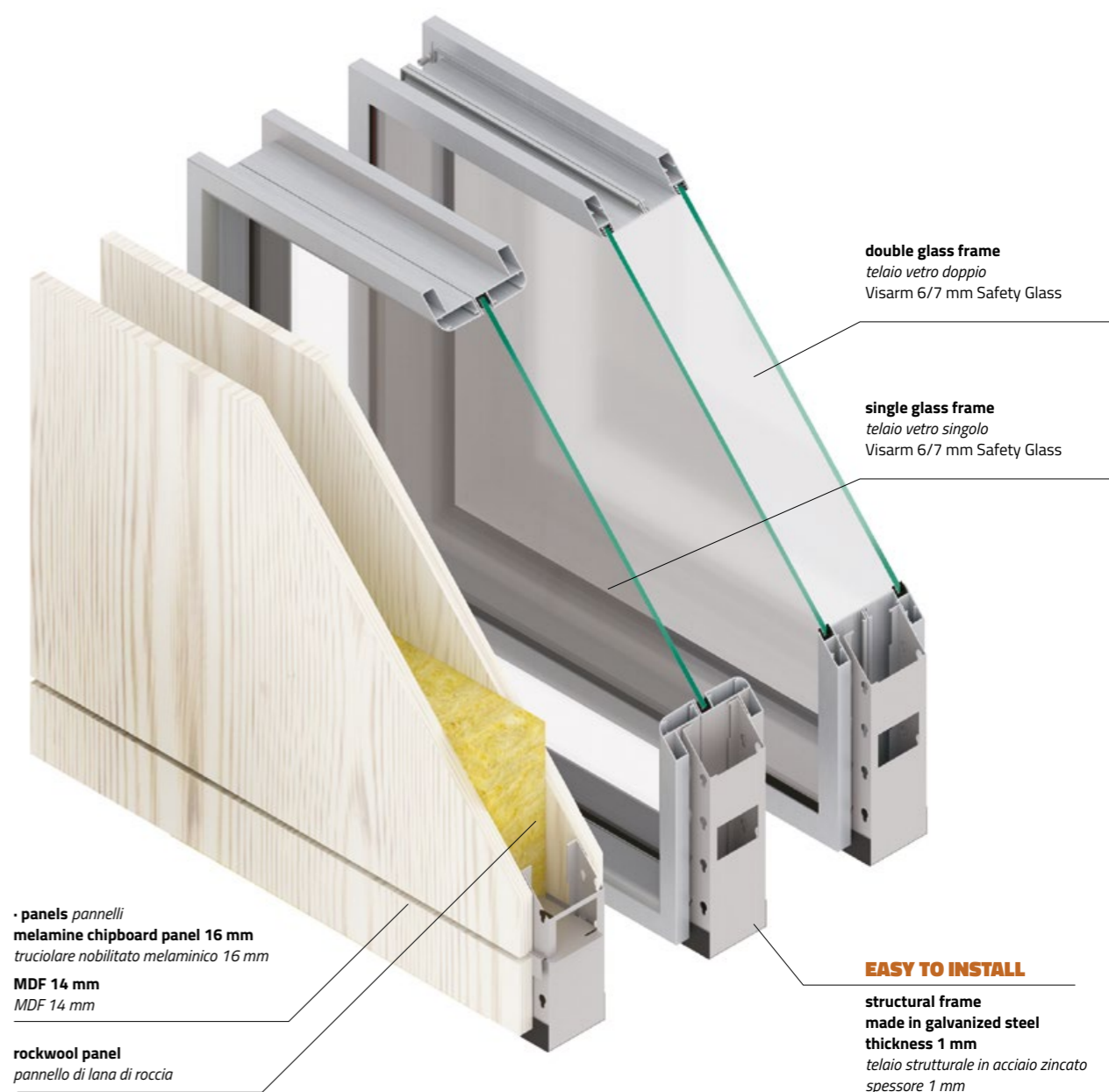
**ACOUSTIC ABSORPTION FONOASSORBENZA**

according to standards UNI 11004

acoustical insulation value with rockwool density 100 kg/m³ (solid partitions) fonoisolanza con lana di roccia densità 100 kg/m ³ (pareti cieche)	46 db
acoustical insulation value with rockwool density 60 kg/m³ (solid partitions) fonoisolanza con lana di roccia densità 60 kg/m ³ (pareti cieche)	37 db
acoustical insulation value without rockwool (solid partitions) fonoisolanza senza lana di roccia (pareti cieche)	29 db
acoustical insulation value with double layer laminated acoustical glass Visarm 6/7 mm (glass partitions) fonoisolanza con doppio vetro stratificato acustico Visarm 6/7 mm (pareti vetrate)	40 db

*partition certification available under request at project dept. of CBI Europe · certificato pareti su richiesta all'ufficio progettazione CBI Europe

GENESY

Static stability without the need for ceiling counterforce, easy installation, unlimited configurability.

Stabilità statica senza necessità di contropinta a soffitto, facilità di installazione, riconfigurabile senza limiti.

STRUCTURES STRUTTURE

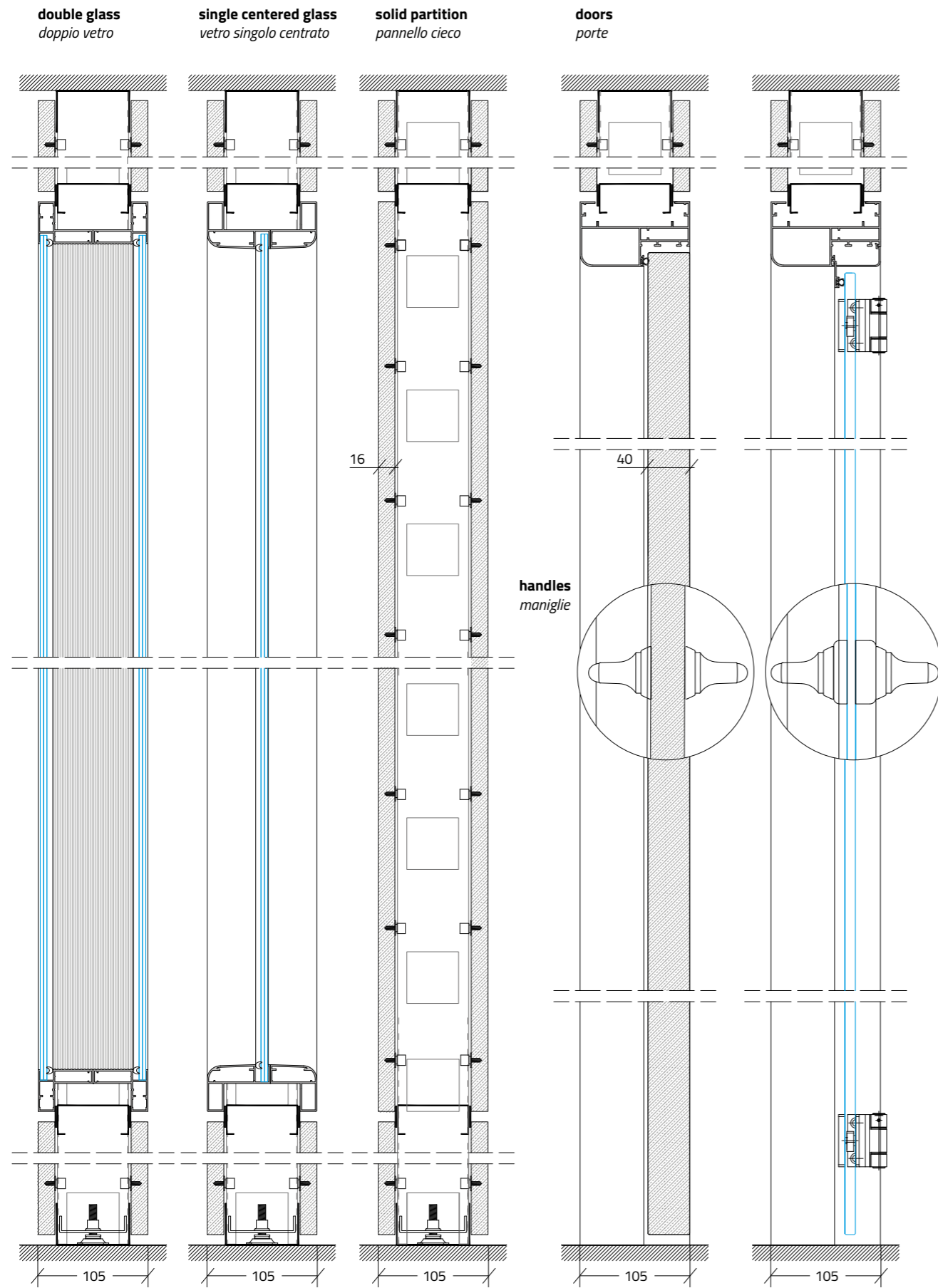

MODULE ABACO ABACO MODULI

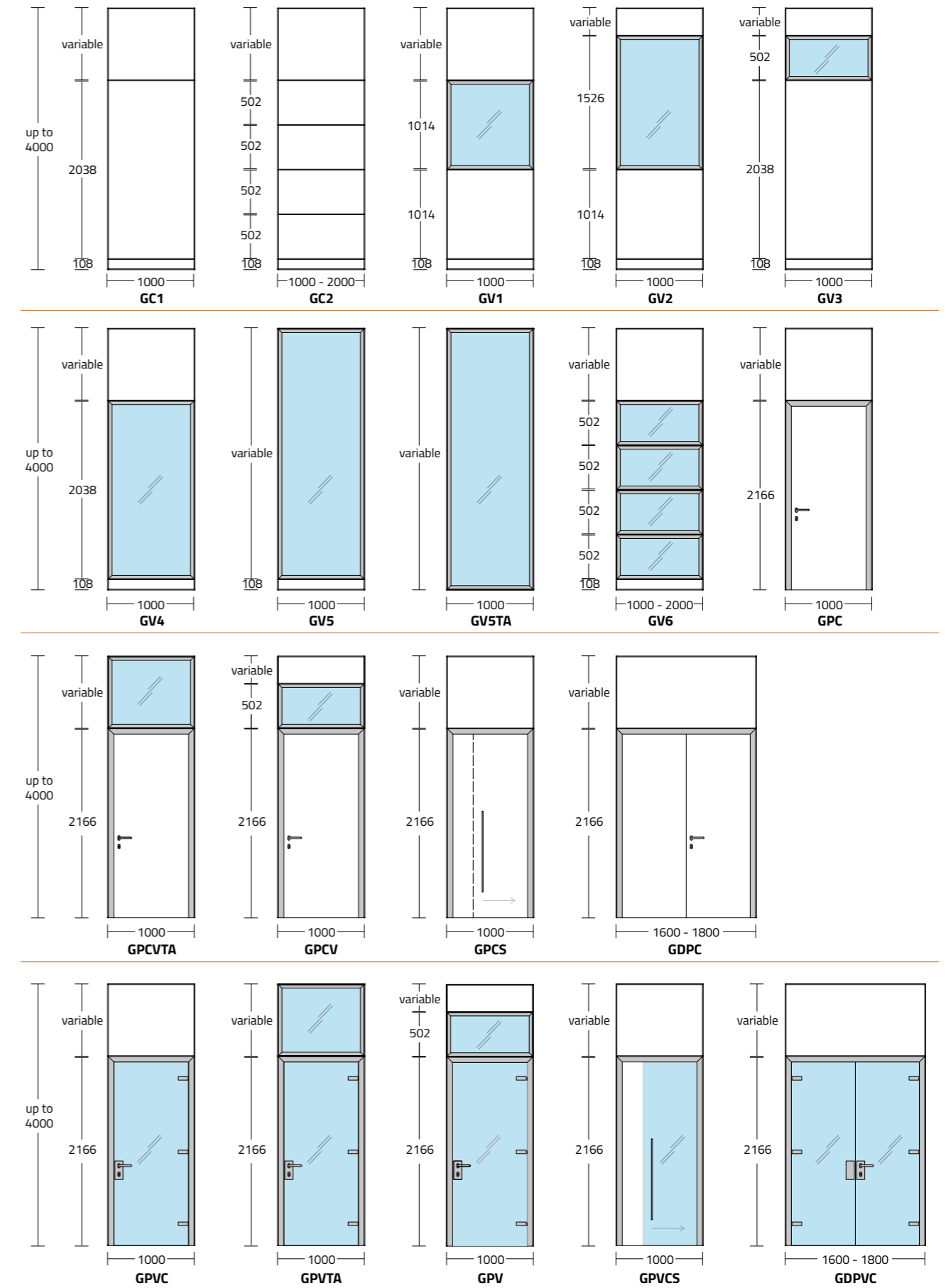

AVAILABLE COLOR FOR PANELS *COLORI DISPONIBILI PANNELLI*



The colour card shown on this page is purely for information purposes; please request samples.

Le cartelle colori riportate sono puramente indicative, si raccomanda la richiesta di campionatura.

TECHNICAL SPECIFICATIONS *SPECIFICHE TECNICHE*

load bearing · <i>resistenza al carico orizzontale</i>	according to standards UNI 10879
resistance of frames · <i>resistenza guide e telai</i>	according to standards UNI 8605/84

TECHNICAL CHARACTERISTICS OF ALUMINIUM COMPOSING ELEMENTS · *CARATTERISTICHE TECNICHE DELL'ALLUMINIO*

alloy · <i>lega</i> 6060/t 5	test UNI 573-3 / UNI 755-2	heat conductivity a 20°c t6 · <i>cond. termica a 20°c t6</i>	175 W/(cm x k)
traction breakage load · <i>carico di rottura a trazione</i>	160 Pascal	specific weight · <i>peso specifico</i>	27 Kg/dm²
yield load limit · <i>carico al limite di snervamento</i>	120 Pascal		

TECHNICAL CHARACTERISTICS OF PANELS · *CARATTERISTICHE TECNICHE DEI PANNELLI*

specific weight · <i>peso specifico</i>	680 Kg/m³	resistance to dry heat · <i>resistenza al calore secco</i>	level 3 UNI 9116
unitary weight · <i>peso unitario</i>	10.88 Kg/m²	variation to light · <i>variazione alla luce</i>	level 5 - UNIPLAST 356/XI
resistance to bending · <i>resistenza alla flessione</i>	16 Newton/mm²	resistance to adhesion · <i>prova di adesione</i>	2,7 Newton
resistance to traction · <i>resistenza alla trazione</i>	0.35 Newton/mm²	surface hardness · <i>durezza superficiale</i>	Level 9H
resistance to abrasion · <i>resistenza all'abrasione</i>	level 5 UNI 9115	resistance to scratching · <i>resistenza al graffio</i>	1.7 Newton
stain resistance test · <i>resistenza alle macchie</i>	level 5 UNI 9114	resistance to dirt · <i>resistenza allo sporco</i>	Level 5
resistance to damp heat · <i>resistenza al calore umido</i>	level 5 UNI 9117	formaldehyde emission · <i>emissione di formaldeide</i>	Class E-1

AVAILABLE COLOR FOR STRUCTURE *COLORI DISPONIBILI STRUTTURE*



AVAILABLE FINISHINGS FOR GLASS *FINITURE DISPONIBILI VETRO*

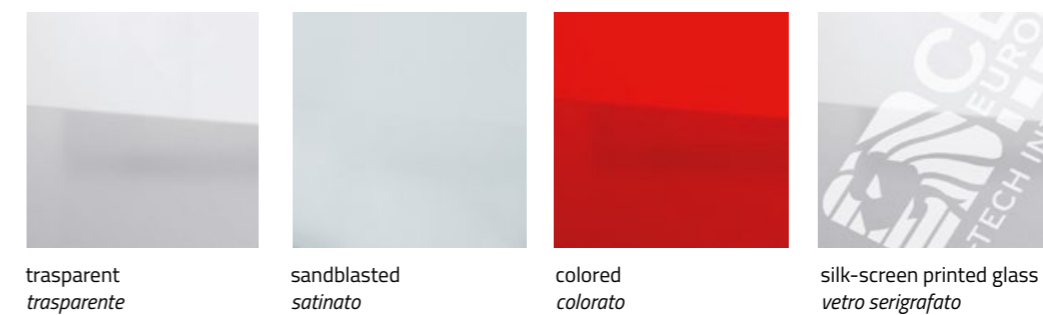



IDEAL FOR

**hospitals - airports - laboratories
data centres - public environments**

IRON GENESY

High-strength wall partitions system *Pareti divisorie modulari ad alta resistenza.*

The Genesy system of modular and joinable partition walls evolves in terms of safety and hygiene, with the new **steel coated IRON panels**. Fully washable, removable and inspectable IRON panels are ideal for public environments, infrastructures, hospitals, laboratories, canteens and all environments where durable and technological finishing materials are required. IRON steel panels can be treated with special antibacterial paints to ensure maximum levels of environmental quality.

*Il sistema Genesy di pareti divisorie componibili e modulari si evolve in termini di sicurezza e igiene con i nuovi **pannelli IRON, rivestiti in acciaio**. Completamente lavabili, rimovibili ed ispezionabili, i pannelli IRON sono ideali per ambienti pubblici, infrastrutture, ospedali, laboratori, mense e tutti gli ambienti dove sono richiesti materiali di finitura resistenti e tecnologici. I pannelli di acciaio IRON possono essere trattati con speciali vernici antibatteriche così da garantire massimi livelli di qualità ambientale.*



HIGH RESISTANCE
ALTA RESISTENZA



ACOUSTIC ABSORPTION
FONOASSORBENZA



HYGIENE & CLEANING
IGIENE & PULIZIA



EXTENDED WORKING LIFE
DURABILITÀ



HIGH RESISTANCE
ALTA RESISTENZA

STEEL COATED IRON PANELS:

Resistant to fire, chemicals and atmospheric agents: high technology of spacing.

PANNELLI IRON, RIVESTITI IN ACCIAIO:

Massima resistenza a fuoco, agenti chimici o atmosferici: alta tecnologia degli spazi.

IRON GENESY

↑
H MAX 4000 MM



IRON GENESY

A shield against noise, for any type of working environment.

Barriera antirumore per ogni tipologia di ambiente di lavoro.

Wood paint imitation
Finitura imitazione legno

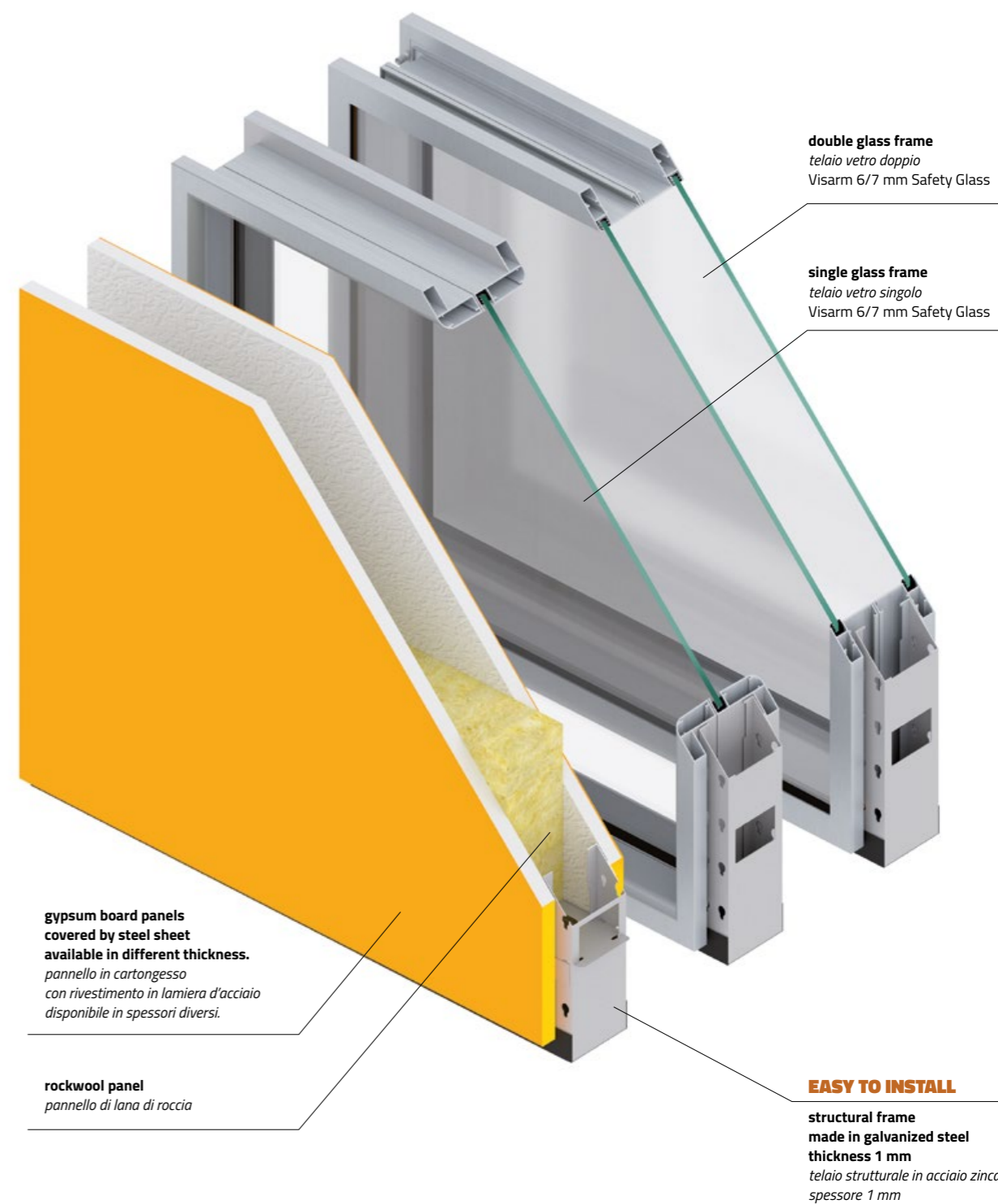

STRUCTURES STRUTTURE

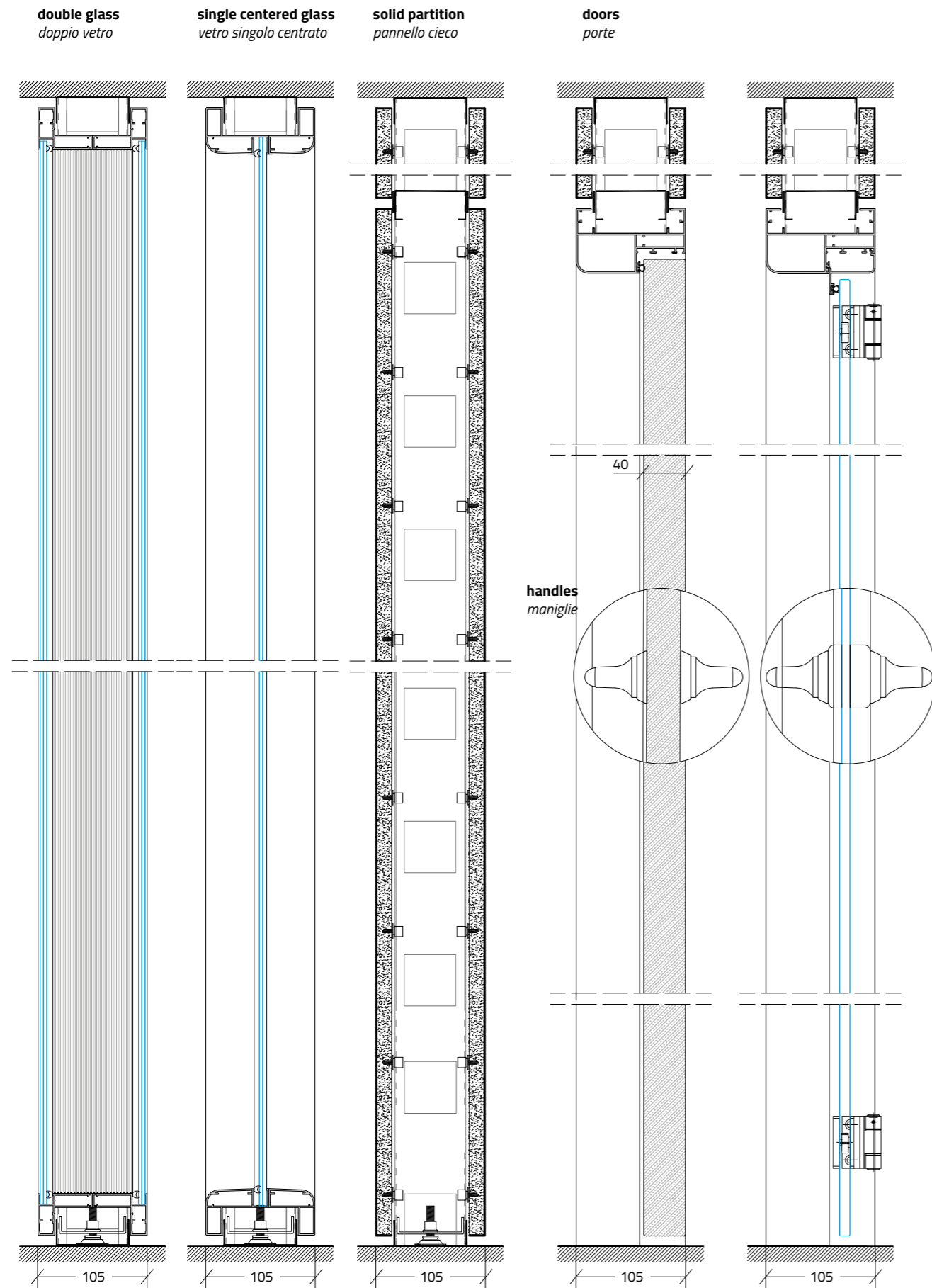

MODULE ABACO ABACO MODULI

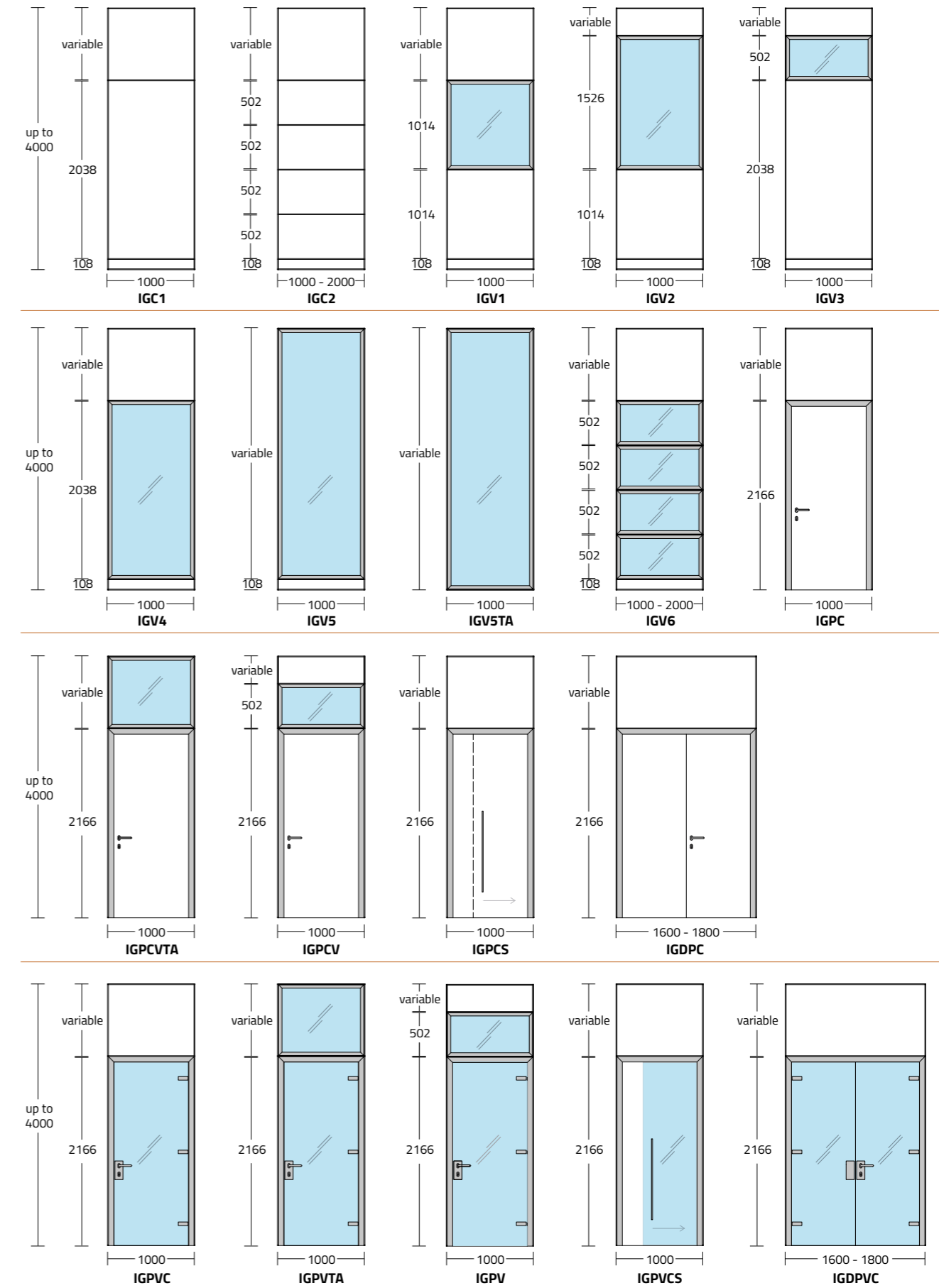



AVAILABLE COLOR FOR STRUCTURE *COLORI DISPONIBILI STRUTTURE*

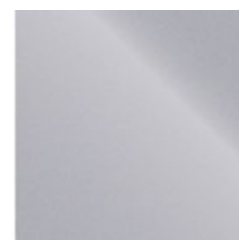

aluminum anodized
alluminio anodizzato

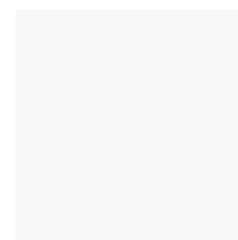

pure white · *bianco puro*
RAL 9010



traffic black · *nero traffico*
RAL 9017



RAL colours
on request · *a richiesta*

AVAILABLE COLOR FOR PANELS *COLORI DISPONIBILI PANNELLI*

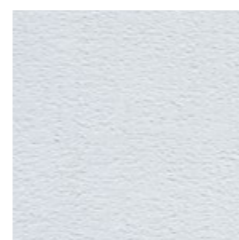

white
bianco

(AS)

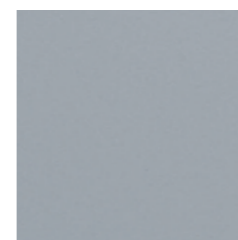

metal grey
grigio metal

(AS)



RAL colours
on request · *a richiesta*

METAL WOOD wood imitation paint · *imitazione legno*

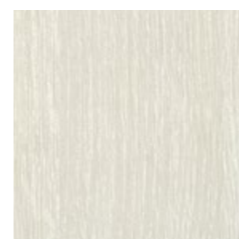

SL57 whitened oak
rovere sbiancato

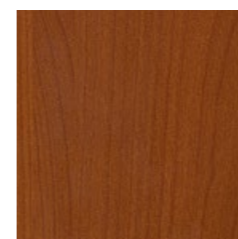

SL56 cherry tree · *ciliegio*

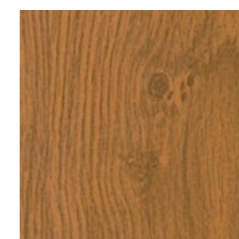

SL252 winchester

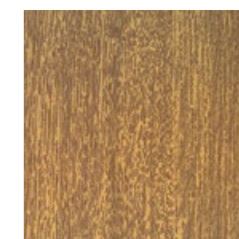

SL02 light oak
rovere chiaro



6869 farm maple

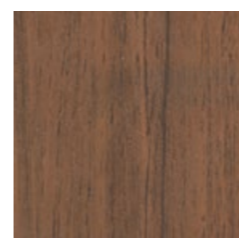

SL28 teak

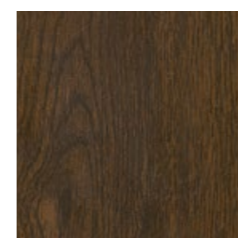

SL39 dark oak
noce scuro

AVAILABLE FINISHINGS FOR GLASS *FINITURE DISPONIBILI VETRO*

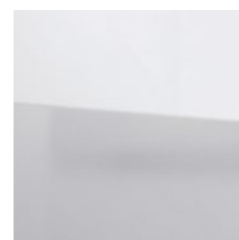

trasparent
trasparente



sandblasted
satinato



colored
colorato



silk-screen printed glass
vetro serigrafato



IDEAL FOR

**offices - open space - meeting rooms
technical and medical environments**

WALL SYSTEM

The 'luminous' alternative to plasterboard *L'alternativa "luminosa" al cartongesso*

Modular elements of design and quality in glass, wood and aluminum, to be assembled quickly and directly on site, contribute to the creation of a new interior concept that goes beyond the simple function of division.

Like a resistant interlocking game, Wall System, in fact, allows you to easily compose, move and modify the individual modules according to organisational needs, architectural choices and personal taste.

The interiors are contemporary, elegant and bright, but above all technical and functional.

Elementi modulari di design e qualità in vetro, legno e alluminio, da assemblare velocemente e direttamente in cantiere contribuiscono alla realizzazione di un nuovo concept degli interni che va oltre la semplice funzione di divisione.

Come un resistente gioco a incastro il sistema Wall System, infatti, permette di comporre, spostare e modificare facilmente i singoli moduli in funzione delle necessità organizzative, delle scelte architettoniche e del gusto personale.

Interni contemporanei, eleganti e luminosi, ma soprattutto tecnici e funzionali.



QUICK INSTALLATION
INSTALLAZIONE RAPIDA



ACOUSTIC ABSORPTION
FONOASSORBENZA



LIGHT WEIGHT
LEGGEREZZA



EXTENDED WORKING LIFE
DURABILITÀ



QUICK INSTALLATION
INSTALLAZIONE RAPIDA

Wall System is the system that revolutionises the logic of assembly on site: it simplifies operations and optimises installation times, without sacrificing the versatility of solutions and functions.

Wall System: è il sistema che rivoluziona la logica di montaggio in cantiere: semplifica le operazioni ed ottimizza i tempi, senza rinunciare alla versatilità delle soluzioni e delle funzioni.

WALL SYSTEM
Lardini headquarters - Filottrano, Italy

DEMOUNTABLE PARTITIONS



90° corner
Angolo 90°



3 way joint
Raccordo a tre vie



Joint cover
Coprigiunto



WALL SYSTEM

Soundproofed environments, structures 100% inspectable, integration with advanced climate control, domotics and lighting.

Ambienti acusticamente corretti, 100% ispezionabilità degli impianti, integrazione con sistemi avanzati di domotica, climatizzazione e illuminazione.



WALL SYSTEM
FOR TECHNICAL
AND MEDICAL
ENVIRONMENTS
PER AMBIENTI TECNICI
E MEDICI

The ability to insert special sound-absorbing panels in the cavity and apply insulating glass increases the acoustic performance.

The system is designed to accommodate plumbing and electrical wiring and is fully inspectionable.

The modules are 100% washable.

Possibilità di inserire nell'intercapedine appositi pannelli fonoassorbenti e di applicare vetri isolanti, per aumentare la performance acustica.

Il sistema è predisposto per il passaggio e l'alloggiamento degli impianti e ogni singolo modulo è completamente ispezionabile.

I moduli sono completamente lavabili.

↑
H MAX 4500 MM

WALL SYSTEM



WALL SYSTEM

Modular elements to be assembled quickly and directly on site.

Elementi modulari da assemblare velocemente e direttamente in cantiere.

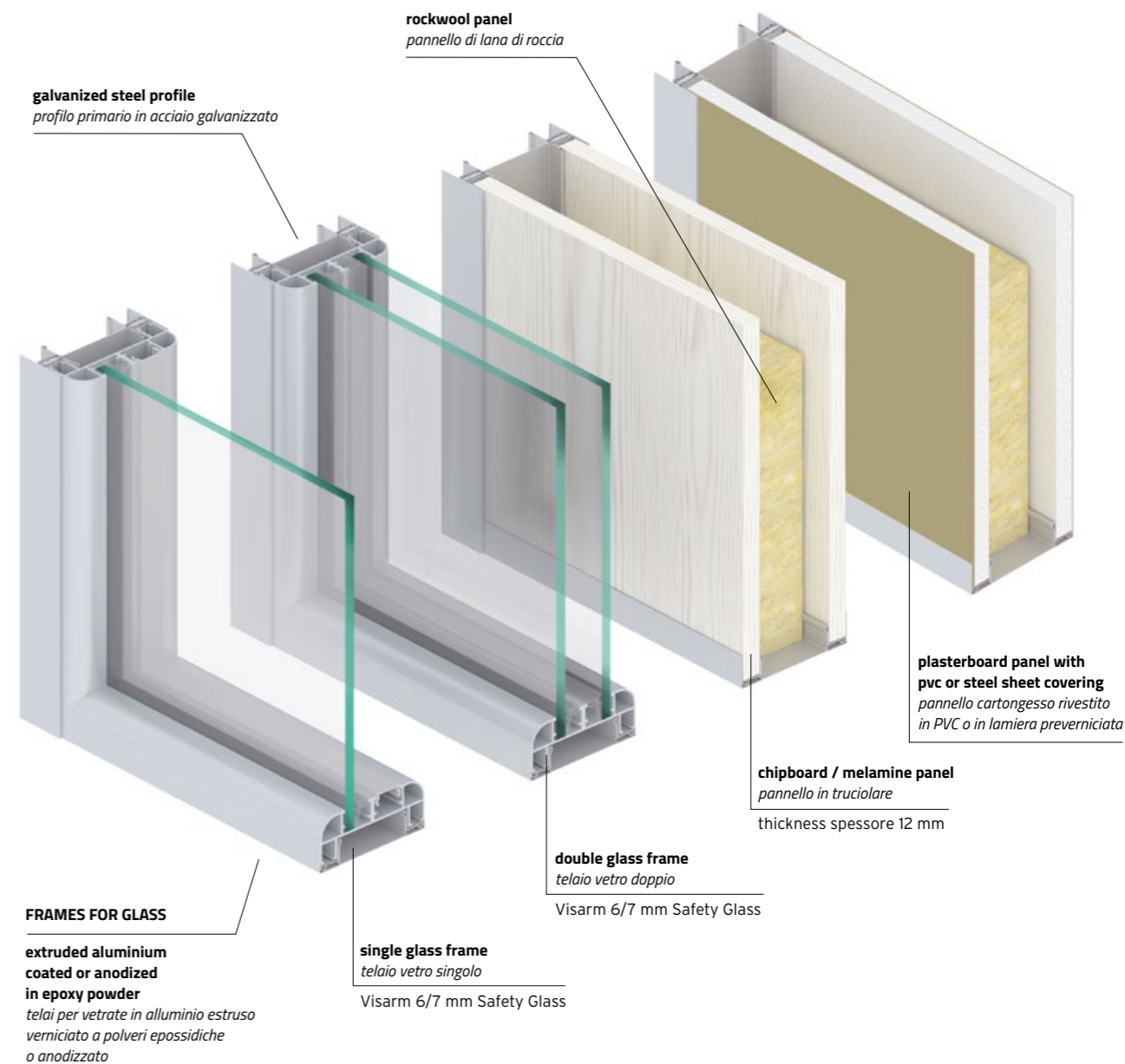

100% STRUCTURES
100% INSPECTABLE

STRUCTURES STRUTTURA

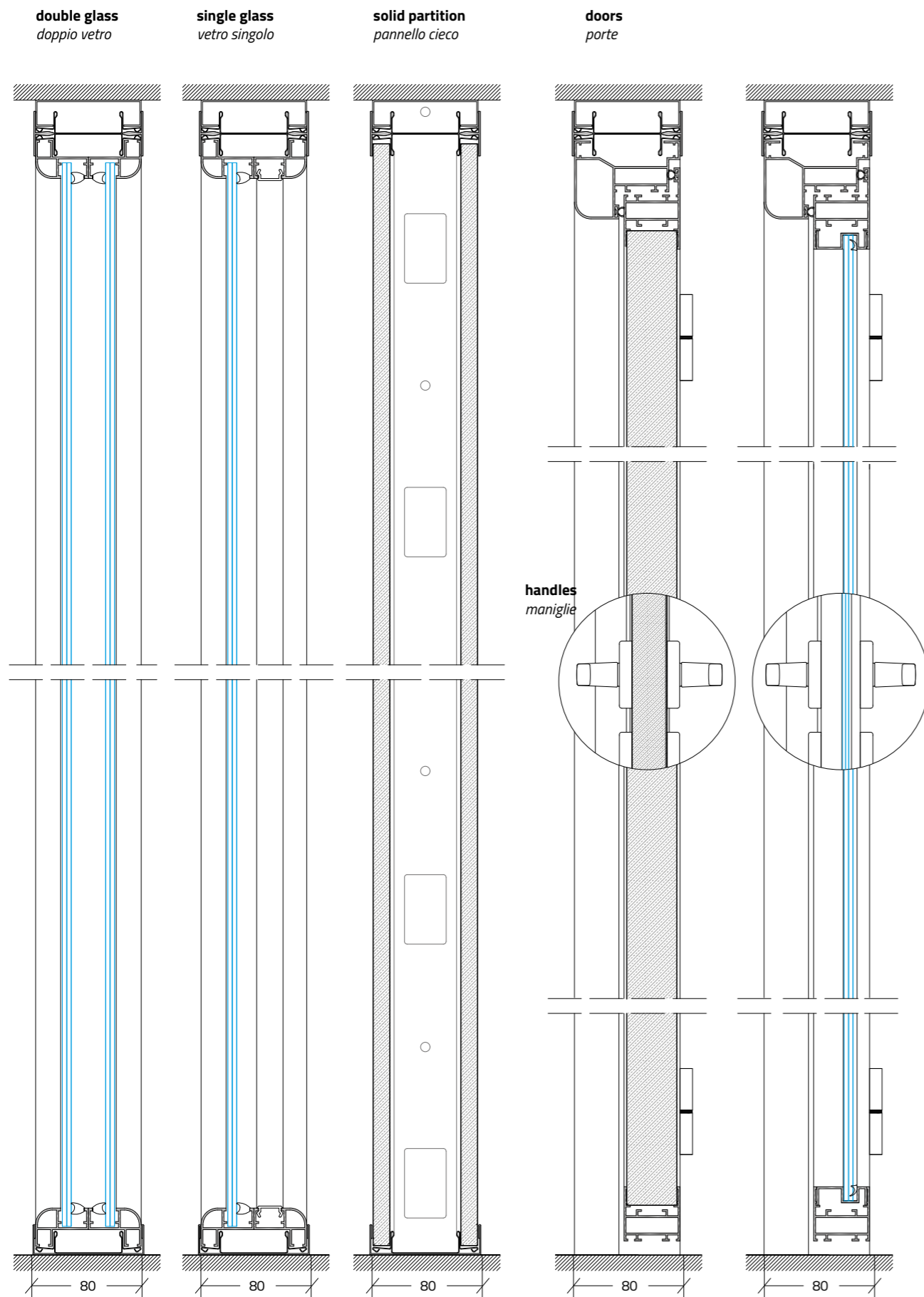

MODULE ABACO ABACO MODULI

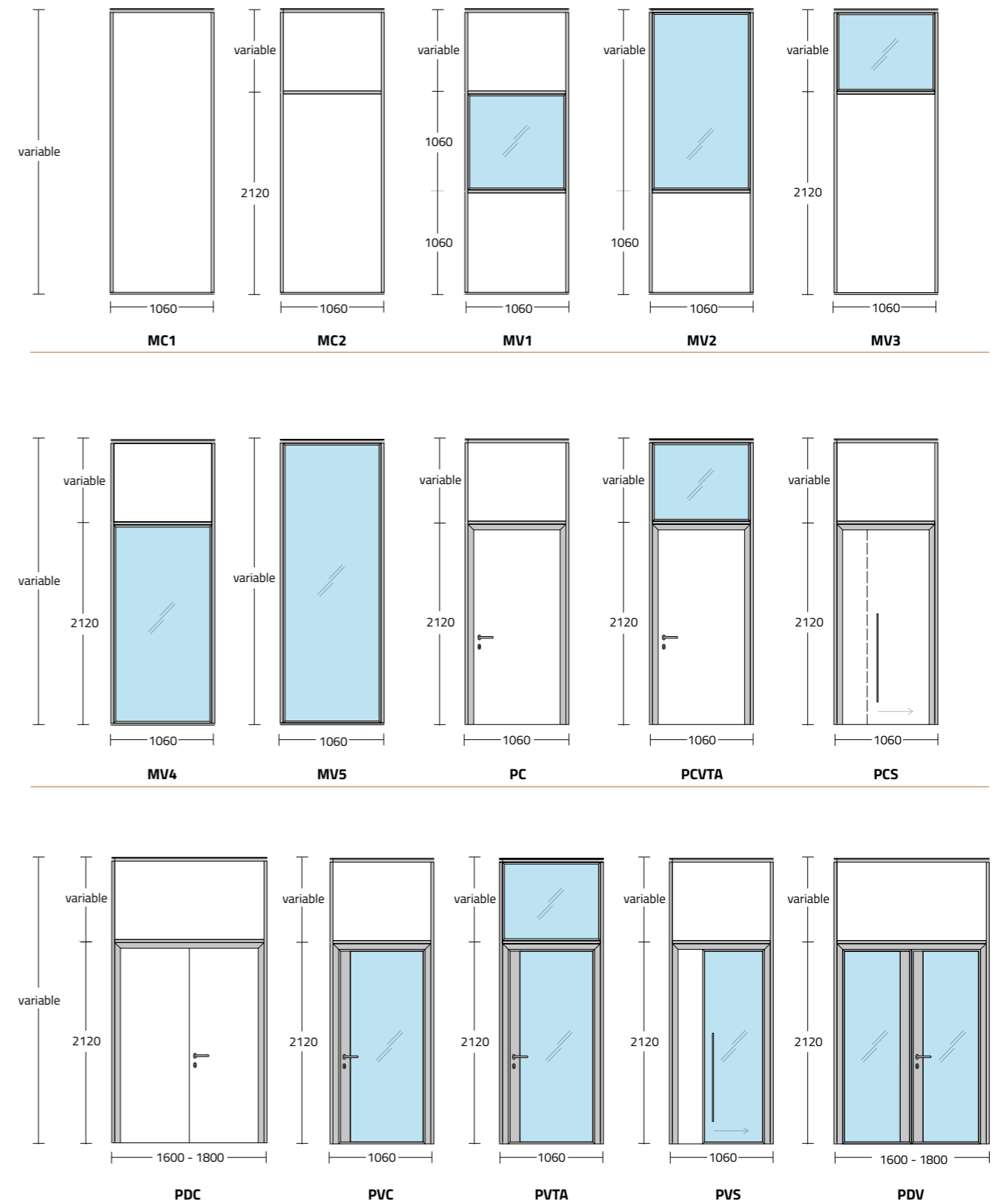

AVAILABLE COLOR FOR PANELS *COLORI DISPONIBILI PANNELLI*

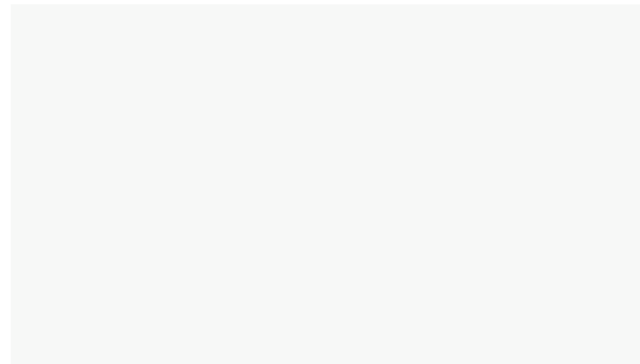

white · bianco

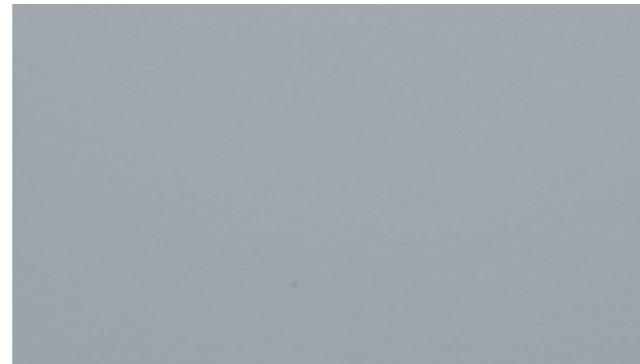

(AS) metal grey · grigio metal

(AS)



aralie D58 · aralie D58

(porolaccato)

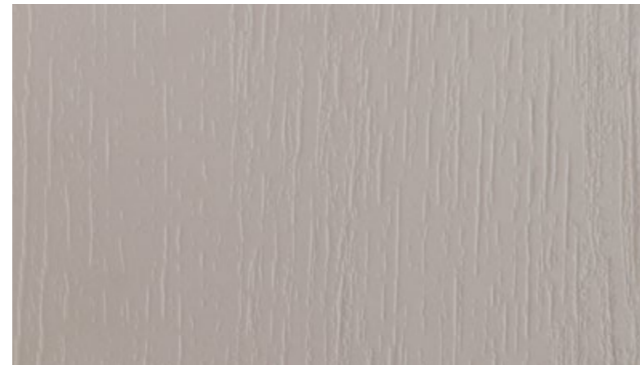

grey AP2 · grigio AP2

(porolaccato)



eureka

(tile)



urban elm · olmo urbano

(tile)

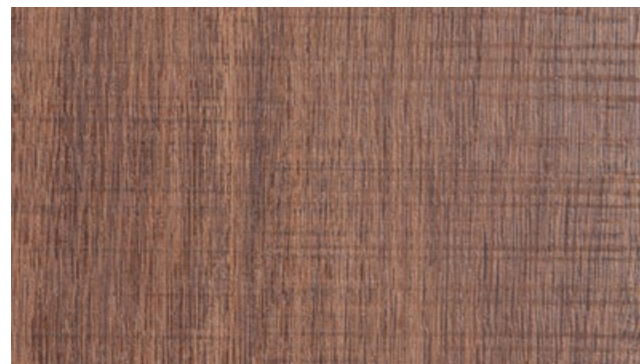

faro oak · tabacco

(artlight)

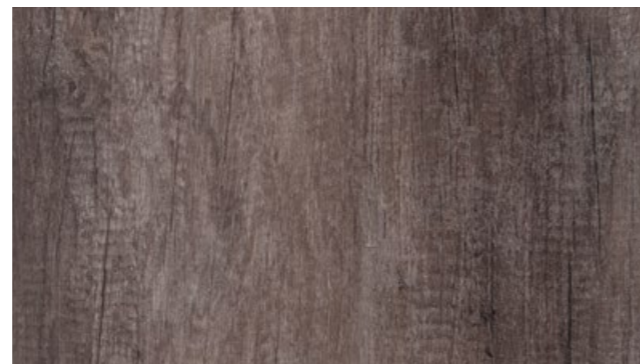

canyon oak · rovere canyon

(artlight)

The colour card shown on this page is purely for information purposes; please request samples.

Le cartelle colori riportate sono puramente indicative, si raccomanda la richiesta di campionatura.

AVAILABLE COLOR FOR STRUCTURE *COLORI DISPONIBILI STRUTTURE*

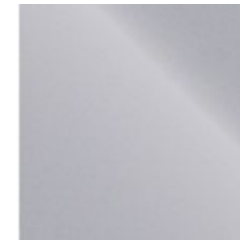

aluminum anodized
alluminio anodizzato

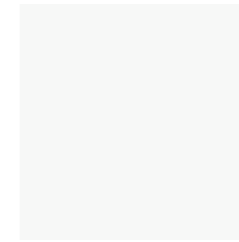

pure white · bianco puro
RAL 9010



traffic black · nero traffico
RAL 9017



on request · a richiesta
RAL colours

AVAILABLE FINISHINGS FOR GLASS *FINITURE DISPONIBILI VETRO*

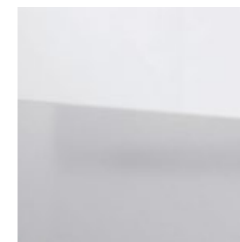

trasparent
trasparente



sandblasted
satinato



colored
colorato



silk-screen printed glass
vetro serigrafato



IDEAL FOR

**multiple-purpose environments: hall
meeting rooms · classrooms · open spaces**

FLEXWALL

Modular, flexible, fast installation

Flessibilità, modularità e velocità di installazione

Flexwall: aluminum suspended ceiling panels with a ceiling guide without any floor fixing. Wall elements - panels and doors - can be moved along the guide, enabling rapid reconfiguration of the environments with extreme simplicity. Lightweight and installable on any type of ceiling, and is customizable with different materials and finishes, providing the ideal solution for variable partitions of multiple-site environments: halls, meeting rooms, classrooms, open spaces.

Available versions:

FLEXWALL 50: light version.

FLEXWALL 110: acoustic version.

Flexwall: pannelli intelaiati in alluminio sospesi ad una guida a soffitto, senza alcun fissaggio a pavimento. Gli elementi della parete - pannelli e porte - possono essere spostati lungo la guida, consentendo una rapida riconfigurazione degli ambienti con estrema semplicità. Leggera e installabile su qualsiasi tipo di soffitto, è personalizzabile nei materiali e nelle finiture: la soluzione ideale per la partizione di ambienti a destinazione multipla come hall, sale riunioni, aule, open spaces.

Versioni disponibili:

FLEXWALL 50: light

FLEXWALL 110: acustica.



SLIDING WALLS SYSTEM
PARETI SCORREVOLI



ACOUSTIC ABSORPTION
FONOASSORBENZA



INTEGRATED ACCESSORIES
ACCESSORI INTEGRATI



EXTENDED WORKING LIFE
DURABILITÀ



SLIDING WALLS SYSTEM
PARETI SCORREVOLI

Splitting environments only when needed: wall elements can be moved along the guide, enabling rapid reconfiguration of the environments.

Suddividere gli ambienti solo quando serve: gli elementi della parete possono essere spostati lungo la guida, consentendo una rapida riconfigurazione degli ambienti.

FLEXWALL 110



FLEXWALL 110

The Flexwall 110 units are made of a frame, a sound-proof panel and a double sided finish of laminated or veneer board. The units are suspended on an aluminium rail fitted into the ceiling plane, and available in various finishes.

Il modulo Flexwall 110 è composto da un telaio, un pannello insonorizzante e finiture in laminato o impiallacciato. Le unità sono sospese ad una guida in alluminio installata a soffitto, e disponibili in varie finiture.



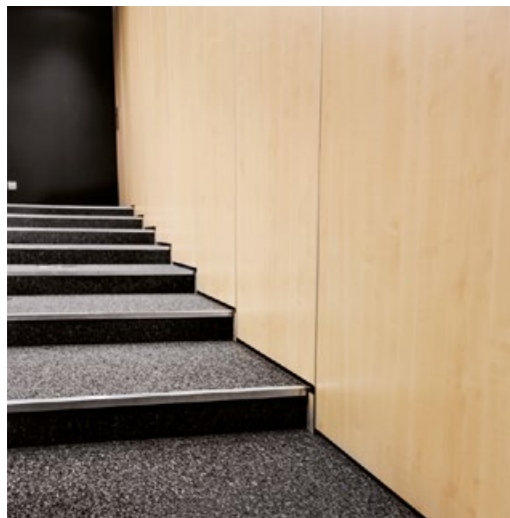
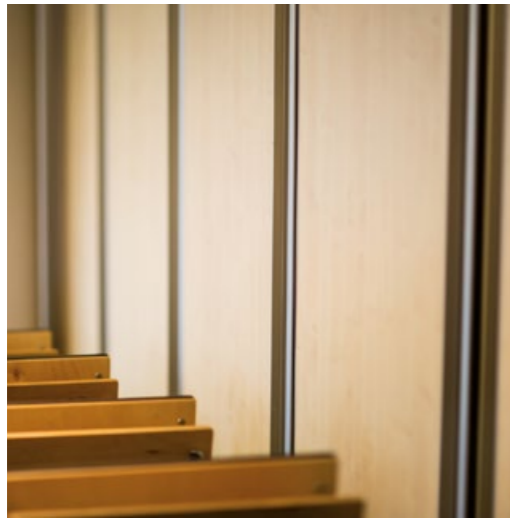
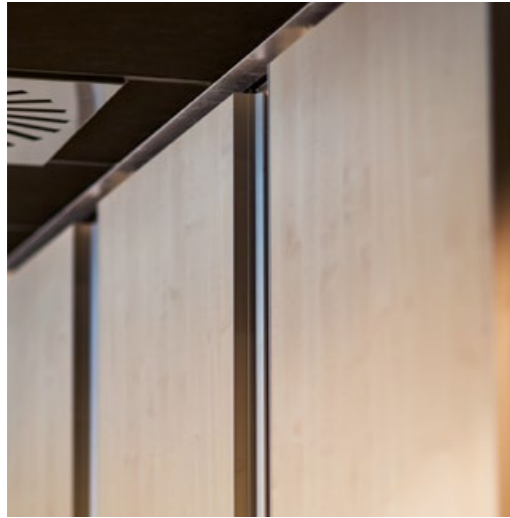

FLEXWALL 110





Splitting environments only when needed. *Suddividere gli ambienti, solo quando serve.*
 Reduced thickness and lightness for quick reconfiguration of spaces. *Spessore ridotto e leggerezza, per una veloce riconfigurazione degli spazi.*
 High acoustic barrier, with manual or semi-automatic operation. *Elevata barriera acustica, con funzionamento manuale o semiautomatico.*
 Available in various finishes. *Disponibile in varie finiture.*





FLEXWALL 50

The Flexwall 50 system was designed with the transparent division of rooms in mind. It facilitates the use of simpler, lighter systems which do not take up a lot of vertical space. That is why Flexwall 50 is the most-often-selected system for use in studio flats and apartments. The partition walls consist of 80 – 100 cm wide units and are height-adjustable to fit any room. Units are suspended on a rail installed in the ceiling.

Il sistema Flexwall 50 è progettato per la divisione degli spazi, nel segno della trasparenza e della luminosità. Moduli semplici e leggeri, facili da movimentare, a limitato ingombro verticale: una soluzione ideale per gli ambienti di lavoro o pubblici quanto per appartamenti e monolocali. Il modulo Flexwall 50 è a base 80 o 100 cm, regolabile in altezza per adattarsi a qualsiasi ambiente, e sospeso al soffitto tramite una guida.

FLEXWALL 50 Reduced thickness and lightness for quick reconfiguration of spaces.
Spessore ridotto e leggerezza, per una veloce riconfigurazione degli spazi.



FLEXWALL 110 High acoustic barrier, with manual or semi-automatic operation.
Elevata barriera acustica, con funzionamento manuale o semiautomatico.



ACOUSTIC ABSORPTION FONOASSORBENZA

	FLEXWALL 50	FLEXWALL 110
 soundproof insulation · <i>isolamento acustico</i>	Rw 33 dB	up to Rw 54 dB

TECHNICAL SPECIFICATIONS SPECIFICHE TECNICHE

panel thickness · <i>spessore pannello</i>	50 mm	110 mm
weight · <i>peso</i>	22 - 28 kg/m ²	36 - 43 kg/m ²
module width · <i>larghezza modulo</i>	800 - 1000 mm	800 - 1000 mm
construction · <i>tipologia costruttiva</i>	tongue & groove	tongue & groove
frame colour · <i>colore telai</i>	anodised aluminium · <i>anodizzato</i>	anodised aluminium · <i>anodizzato</i>
suspended · <i>sospensione</i>	1 / 2 points · <i>1 / 2 punti</i>	1 / 2 points · <i>1 / 2 punti</i>
doors · <i>porte</i>	single · <i>singola</i>	single / double · <i>singola / doppia</i>
operation · <i>operazione movimento</i>	manual · <i>manuale</i>	semi automatic / manual · <i>semiautomatico / manuale</i>

STARTING ELEMENT-END WALL ELEMENTI DI INIZIO-FINE PARETE

concealed *struttura nascosta*

standard *struttura a vista*

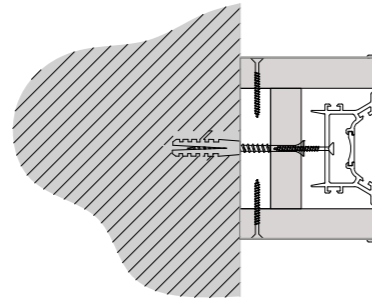
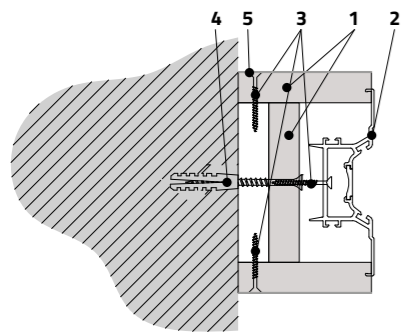

- 1 Melamine chipboard panel *Pannello nobilitato melaminico*
- 2 Extruded aluminium profile *Profilo in alluminio estruso*
- 3 Screw *Vite*
- 4 Dowel *Tassello*
- 5 Melamine chipboard panel *Pannello nobilitato melaminico*

SUSPENSION SYSTEMS SISTEMI DI SOSPENSIONE

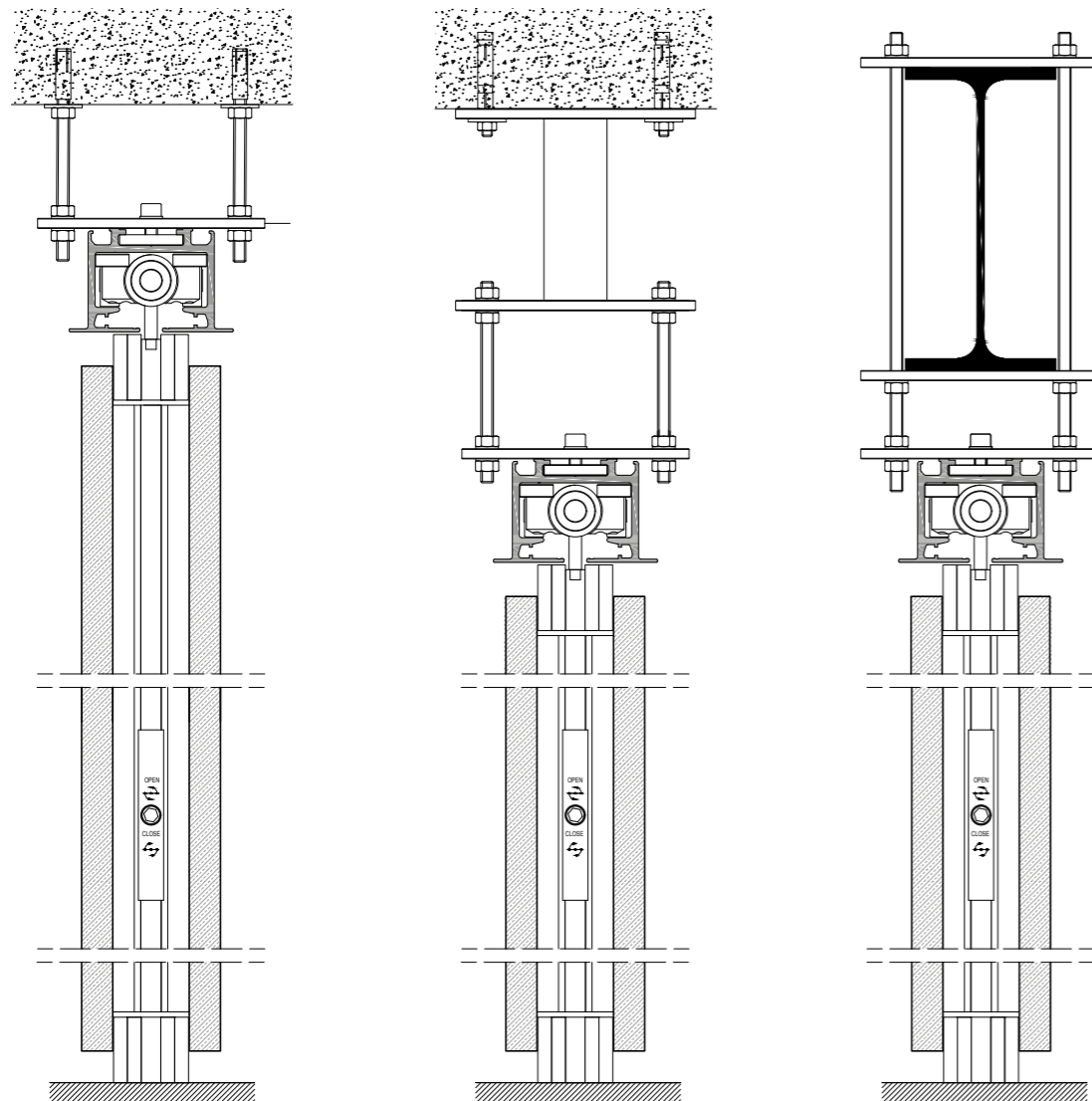

AVAILABLE COLOR FOR PANELS COLORI DISPONIBILI PANNELLI

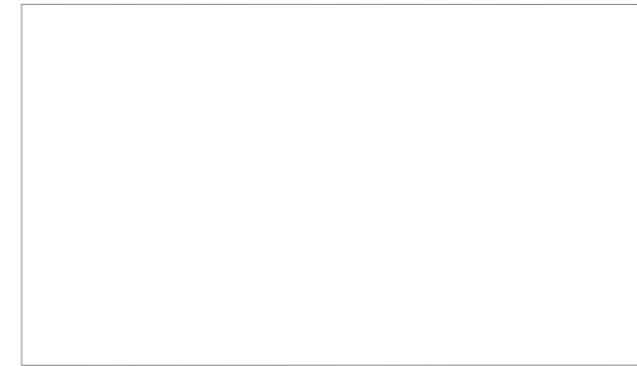

U570 white porcelain



U540 stone grey



D3810 nice walnut



D1917 milan ash



D1926 moscow ash



D3191 cracow elm

*other colors available under request - *altre finiture a richiesta*

AVAILABLE COLOR FOR STRUCTURE COLORI DISPONIBILI STRUTTURE

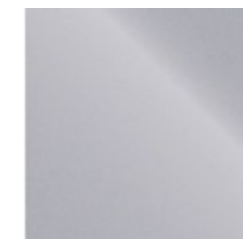

aluminum anodized
alluminio anodizzato

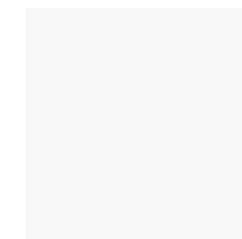

pure white · *bianco puro*
RAL 9010



RAL colours
on request · *a richiesta*

Having over
35 years of
experience and
a network of
partners all over
the world, allow
us to take care
of the realization
of your complex
construction
projects.

ANGOLA

The Financial City › *Talatona* · Chicalamar Building · Kimpavita Offices › *Luanda*

AZERBAIJAN

Aquatics Center European Games · Offices Business Park · Haydar Aliyev Airport › *Baku*

BANGLADESH

Grameenphone › *Dhacca*

BELARUS

Byelorussian Steel · Works BMZ · Mozyr Oil Refinery MNPZ · Gomeldrev Js · Gomeglass › *Gomel* · Heat station n°5 · National Bank of Belarus › *Neman* · Byelorussian Steel Works › *Zhlobin* · JSC Grodno Azot › *Grodno* · Heat-Electric Generating · The Mobile Telesystems Joint LLC › *Minsk* · Fe Velcom › *Minsk and others cities* · Rue Beltelecom Minsk › *Mogilev and others cities*

BELGIUM

A.G.C. Glas Company › *Gosselies* · Les Portes du Lion › *Waterloo* · Eco Power › *Ham* · Vanreyschoote › *Sint Denijs Westrem* · Zottgem Sanitary › *Zottegem* · Notre maison › *Louvain-La-Neuve* · Connect Immo › *Namur* · ESA › *Redu* · ABN Amro Bank · Antwerp Trainstation · Atlas Copco · MSC Station › *Antwerp* · Ikaros · Diabolo › *Zaventem* · DP World · Antwerp Gateway · European Space Agency · Redu Electrawinds › *Oostende* · Infrabel · Samsonite · *Oudenaarde* · Siemens · Omnicem › *Wetteren* · Krones · L'Oreal · VRT Waterfront offices · Unizo · Cortenberg 107 · Elimo › *Brussels* · Court Of Justice · OTC · Arcelor Mittal · Gerechtsgebouw › *Ghent* · Telenet › *Mechelen*

BULGARIA

Vision Hospital › *Sofia* · Biovet JSC › *Peshtera* · Municipality of Dalgopol · Sports Hall · Varna Airport › *Varna* · Devnya Cement › *Devnya* · Info center · Grawe Office Building › *Sofia*

CROATIA

Ict King Buzin · Immorent business center Instrumentarija business center › *Zagreb* · Imobilia Tehno Iii & Iv · Otok M-San residential and business center › *Rugvica* · Komunalac business center › *Samobor*

CYPRUS

Tsys Offices At Annex · Trust Building › *Koustais* · Demetra Ependitiki · Panicos Nicolaides Offices Consulco Project · Rik · Crestpoly Building · Cyta · Shiacolas Elmeni Cycleair H&D · Mavrommatis building · Renaissance · National health services · Nicolaides building · Air Control Building · Hadjihannas · Alpha Bank · Popular Bank · Hellenik Bank · Jcc Credit Card · Clearance Centre · Rai Consultants · Stock Exchange Market University Of Nicosia Water Board Department A.G. Papaellinas Offices · Land Registry Of Nicosia · General Hospital · Cyprus Telecommunication Authority · Zefix › *Nicosia* · Lofitis Business Center › *Medstar* · Interorient › *Limassol* · Larnaca Airport · Laiki popular bank · Aek offices Insurance Company Of Popular Bank · Popular Bank District Office Agios Iazaros › *Larnaca* · Electricity Authority Substations › *Platres and Nicosia* · Athinodorou Business Centre › *Paphos*



Campus Palmas Altas · Seville, Spain

The first building in Europe to be awarded the PLATINUM LEED certification in 2009

ANGOLA
AZERBAIJAN
BELGIUM
BULGARIA
BANGLADESH
BELARUS
CROATIA
CYPRUS
EGYPT
EQUATORIAL GUINEA
ESTONIA
GREECE
HUNGARY
ICELAND
IRAQ
IRELAND
ITALY
JORDAN
KAZAKISTAN
KUWAIT
LATVIA
LEBANON
LITHUANIA
MALTA
MEXICO
MOROCCO
MOZAMBIQUE
NEW ZEALAND
NIGERIA
PAKISTAN
PORTUGAL
QATAR
ROMANIA
RUSSIA
SAMOA
SAUDI ARABIA
SERBIA
SLOVAKIA
SLOVENIA
SPAIN
SWITZERLAND
TUNISIA
TURKEY
UAE
UKRAINE
UNITED KINGDOM
UNITED STATES
YEMEN



The Mark Office Tower · Bucharest, Romania



Qatar Olympic Sport Museum Qosm At Khalifa Stadium · Doha



Mill Park Cognizant offices · Budapest, Hungary



Japanese University · Alexandria, Egypt



Memorial Hermann Medical Plaza · Houston, USA



Openville · Timisoara, Romania



Coop hypermarket · Terni, Italy



Aston Building · Košice, Slovakia



Officine Garibaldi · Pisa, Italy



Equilibrium Office Tower · Bucharest, Romania



Hotel Hilton · Tallin, Estonia



Comune di Livorno · Livorno, Italy



Conad hypermarket
Ancona, Italy



EGYPT

Japanese University · Edf Electricità De France · Alexandria · Mercedes-Benz Showroom El Dokki District · Media Production City · Administrative Premises for Egyptian Banks Company (EBC) · Egyptian General Intelligence · Milks Company · National Egyptian Bank · Burj Al Arab Branch · Arab Investment Bank · Minya Governorate Branch Arab Investment Bank: 5th District Branch, Al About District Branch, Al Arab Mall Branch 6th October City · Export Development Bank of Egypt · Shobra District Branch · Ahly United Bank · Bloom Bank · Cairo Airport · Cib Bank · Cairo · Marsa Matrouh · Hurghada · Aswan Sport Stadium · Aswan City · Nile Sat Extension Building · October City

EQUATORIAL GUINEA

Sipopo Congress Center · Malabo

ESTONIA

Conference center Maakri tn.19 · Hotel Hilton Strategic Communication Centre · Hansapank Server Building · Tallin

GREECE

Cosmote office building · OPAP office building · Aspropyrgos office building · Dol office building · Glyfada office building · Opera House · Eurobank Head Quarter · Regency Casino Mont Parnes · S&B Industrial Minerals S.A. Tennis Pavilion · Olympics 2004 Yamaha Building · Athens · Opera House · Technical School Of Kalamaria · Thessaloniki

HUNGARY

Promenade Garden offices · Mill Park Cognizant offices · Budapest

ICELAND

Isavia Airport authorities · Orkubú Vestfjarða Ossur head office · Mjólkursamsalan company Ríkisútvarpið · State Television Lýsi hf · Íshúsfélag Vestmannaeyja plant Municipal office in Greenland · Reiknistofa bankanna · IT service head office · Íbúðalánasjóður · Housing Financing Fund office · Bp Head office · Reykjavik

IRAQ

Çalik Holding

IRELAND

Langan Quay Office Development · Belfast · Cherrywood Block F · Shop On Liffey Street · Dublin · City Gate Business Center Mahon · Cork · City Square shopping centre · Student Accomodation Waterford Institute · Waterford

ISRAEL

Galil Medical · Boston Scientific BTG Group Offices · Yokne'am Illit

ITALY

Sala Asia Poste Italiane · Palazzo di via del Serafico 200 · Palazzo Italia · Pontificio Collegio Americano in Vaticano · Nuova stazione Tiburtina · Banca Popolare di Vicenza · Roma · Sede Amazon · Bosch Italia Siderurgica Latina Martin Spa · Gesa Vending · Milano · Istituto Zooprofilattico Sperimentale Sige Spa · Ancona · Sala Danza Liceo Pascal · Pompei (NA) · Cejn Italy · Sesto San Giovanni Unigrà Srl · Conselice (RA) · New Efore · Osimo · Coop · Terni · Conad · Pescara · Centro Polifunzionale di Campotenesse · Parco del Pollino Calabria · Comune di Livorno · Ufficio Anagrafe · Livorno · Officine Garibaldi di Pisa · Pisa · USL Teramo · Teramo · Hops! birreria F.lli Simonetti Spa · Civitanova Marche · Teatro Acca · Montella · Nuovo Auditorium · Camposanpiero (PD) · Istituto Patriarcale del Vaticano · Venezia · Enel Spa · Energy Resources · Jesi · Ferrero Spa Office Building · Alba · Infissi Design · Treia · Elerico Home · Recanati · Liomatic · Rieti · Colonna Park Hotel · Porto Cervo · Studio Brunetti e Catanossi · Sistema Edilizia Perugia · Scai · Perugia · Hotel Le Grotte · Genga (AN) · Pineta Hotel · Monsano (AN) · Villa Rugani · Siena · CPF Costruzioni SPA · Firenze · Marcelloni · Terni · Cepu · Villaggio Olimpico Sestriere · Lavazza Spa · Torino · Serrature Meroni · Lentate sul

Seveso (MI) · Glem Gas · Modena · Associazione Industriali · Reggio Emilia · Customs offices port · La Spezia · Colonnara Park Hotel · Porto Cervo Security Offices · La Spezia · Findomestic · Assilichi Spa · Firenze · Novartis Spa · Siena · Sandy caffè · Arezzo · Ufficio Anagrafe · Pistoia Interporto · Chieti · Bacchicocchi · Somacis Group · Castelfidardo (AN) · Banca d'Italia · Terni Camera di Commercio · Lucca · Piaggio Spa · Pontedera · Ospedale di Todì · Todì · Office Development · Pisa · Fellowes Leonardi Spa · Camerano (AN) · Elica Spa · Fabriano · Ferro Adriatica Spa · SMA Rinascente Group · Osimo Agroalimentare Monaldi Spa · Ascoli Piceno · Cartechini Argenterie · Corridonia (MC) · Bieffe Spa · Sapore di Mare Spa · Macerata · Cort House Office · Tolentino (MC) · Di.Ba · Pesaro · Cepu · Città di Castello (PG) · Hospital of Andria · Andria (BA) · Banca Popolare · Università di Bari · Bari · Università di Foggia · Foggia · Antonio Capaldo Spa · Avellino · Oleificio Rocchi · Lucca · Azienda Ospedaliera Rummo · Benevento · Enel · Caserta · Futura Line Industrie · Alenia Spa · Capodichino Airport · Centro Commerciale CIS Centro Commerciale Mandi · Corallo Oromare Project · Poste Centrali · Il Tarì Project · Intesa Bank · Napoletanagas Spa · Porto di Napoli · Sanpaolo IMI Bank · Alenia Spa · Regione Campania · Tribunale · Uffici Inail · Napoli · Telecom Spa · Palermo · Università di Fisciano · Salerno · Ospedale di Matera · Matera · Call Centre · Enna · Life Guard · Catania · Azienda Ospedaliera Papardo · Messina · Base Nato · Sigonella (CT) · Tribunale di Siracusa · Siracusa



Cosmote head quarter, Karela Office Park · Paiania, Greece
The first building in Greece to be awarded the Gold Level of LEED certification in 2013

JORDAN

Telecom › *Shaban* · Crowne Plaza Dead Sea Resort › *Swemeh* · Arab Islamic Bank Jordanian–Syrian border–Jabber · Army Financial dept · Housing Bank · Communication board › *Amman* · Mafrag Military Hospital › *Al Mafrag* · Housing Bank › *Salt Gate & Aqaba Br.*

KAZAKHISTAN

Astana Expo 2017 · KazMunayGas › *Astana* Almaty Metro › *Almaty* · Broadcast relay station › *Semey* · Kaztelradio › *Ridder*

KUWAIT

Kuwait National Petroleum Company › *Al Ahmadi* · The Training Vocational Institute for Girls › *Al-Jahra* · Kuwait National Guard · Kuwait Institute of judicial & Legal Studies Wataniya HQ · KIPCO Tower · KOC Fire Station · Ministry of Health · PAAET project Arabization Medical Center · KISR Admin building · KOTC Building · Ministry of Public Works › *Safat* · Khlijia Tower Gulf Consult · New Japanese Embassy · Mushrif · Middle East Digital Communication · Symphony Complex Project › *Salmiya* · Mubarakiya Tower Kuwait Airport · Kuwait University · Khlijia Tower · Gulf Consult · Koc · Kuwait Oil Co. Artaal Office Project · Al Bahar Tower Al Dhow Tower › *Kuwait City*



Famfa Oil Tower · Lagos, Nigeria

Swan Office Park · Bucharest, Romania
Winner of the RoGBC Green Building Project of the year award · 2011**LATVIA**

Riga Forest School · International Airport › *Riga*

LEBANON

Future TV › *Beirut*

LITHUANIA

Eika Business centre · Green Hall 2 · Baltijos Gildija · Apranga Office · Ainava Project Problematika Project · Park Town · The Museum Of Genocide Victims › *Vilnius* Magnum business center · Kauno Dokas · Shopping center Molas · Business Centre 349 › *Kaunas*

MALTA

Life Sciences Park › *San Gwann* · Malta Information Technology Agency (MITA) › *St Venera* · Wurth New Premises › *Zebbug* · Vodafone Offices · Aps Bank › *Swatar* · Melita Cable Plc › *Madliena* · The Point Commercial Centre › *Tigne* · University Of Malta · ICT Faculty Building › *Msida* · Go Plc › *Marsa* · Connection Café · Malta International Airport · Malta Air Traffic Control (MATS) › *Luqa*

MOROCCO

Morocco ONE · Marine Royale · Direction des statistiques › *Rabat* · OCP Group › *Safi/ Youssoufia* · Amendis · *Tétouan* · Sevam › *Casablanca* · Jeers Industrie /Novatis Group › *Berrechid*

MOZAMBIQUE

Eni Headquarter › *Maputo*

NEW ZEALAND

Half Moon Bay · Kingsway College · Pakuranga Library · Birkenhead Library · Botany Clinic Albany Office Park · St Margaret's College · Unitec Institute of Technology · Extreme › *Auckland* · Christchurch Hospital › *Christchurch* · Alpha Pharmaceuticals › *East Tamaki* · Cameron Road › *Tauranga* · Furniture City · City Fitness Hamilton · MOE › *Hamilton* · City Motor Group · Gilmore Brown › *Whangarei*

NIGERIA

Famfa Oil Tower › *Lagos* · CBN Central Bank of Nigeria · Head quarter › *Abuja*

PAKISTAN

Office Complex › *Karachi*

PORTUGAL

Miranda Law Firm › *Lisbon* · Casa da Calçada Hotel › *Amarante* · PNB Building › *Braga* · Royal Óbidos Spa & Golf Resort › *Óbidos* Casfil Headquarters › *Santo Tirso* · Trielle

Offices › *Aveiro* · Enviroil Offices › *Chamusca* Tecmaia · Science and Technology Park › *Maia* Project Raeye · Atlantic Network of Geodynamical and Space Stations › *Santa Maria, Azores* · Novo Banco – Agencies › *Coimbra and other cities* · Fidelidade Insurance · *Lisboa* · Gaia City Hall · Data Center › *Gaia* · Borgwarner Production Plant › *Viana do Castelo* Edp Ribeiradio – Ermida Dam › *Sever do Vouga* · Ctt Post Office › *Coimbra* · Epimetheus Offices · AVIZ Building Porto Business School National Union of Bank Employees · *Sã Carneiro Airport* › *Oporto* Portugal · Data Center › *Figueira da Foz* · Nato Operational Command · Data Center › *Oeiras*

QATAR

Lusail Office Tower (COM 18) · Qatar Olympic Sport Museum Qosm At Khalifa Stadium · Qatar Petroleum District Qpd Tower 10 Noc Tower · Qib Qatar International · Islamic Bank Gulf Mall Building › *Doha* · Qatar Petroleum hoffice · Al Samerya Tower Le Mirage Hotel Beach House · Urbacon Co. Head Office · MOI Criminal Department · Al Duhail Police Complex · QP Main Serve Room Abu About Area · Living In Car ShowRoom · Industrial Area · Ooredoo Office · 14 Sever & Qtel Rooms Guard House at Qatar University · Gulf east trading & contracting West bay Area · Al Faisal Tower · Qatar University · Room lekhiya stadium · Qatar General Insurance World Trade Center Tower · QP Tower · Club House Al Wajba › *Dukhan Area* QGIRCO Branches at Murra & Al Khore area Project › *Al Khour*

ROMANIA

Tiriac Tower Buzesti Olympic Swimming Pool Project · One Tower One Floreasca City · Equilibrium Office Tower The Mark Office Tower · Campus 6.2 6.3 · Campus 6.1 Office Tower · Stefan cel Mare Building · AFI Business Park · Interio Eurobank · HP Hewlett Packard · Kandia Chocolate Factory · Piata Vitian · Dagesh Group Constructi · General Construct · Swan Office Park · Cascade Park › *Bucharest* · Openville › *Timisoara*

RUSSIA

Airport Kurumoch › *Kazan'* · Mission Control Center › *Korolev city* · Lesoparkovaya metro station · Park Pobedi metro station · Zhulebino metro station · Yandex Office · Silver City Project · Panasonic · Rosnano Office · Yandex Office › *Moscow*



Lusail Office Tower (COM 18) · Lusail, Qatar



Magnum business center · Kaunas, Lithuania



University of Nicosia · Nicosia, Cyprus



Aquatics Center, Baku · Azerbaijan



Nestlé E2V · La-Tour-de-Peilz, Switzerland



Qatar Petroleum, WTC · Doha



Office Biovet · Peshtera, Bulgaria



International Airport · Riga, Latvia



Noc Tower, Qiib Qatar International Bank · Doha



Queen Mary University · London, UK



New line 9 metro · Barcelona, Spain



Astana Expo · Kazakhstan

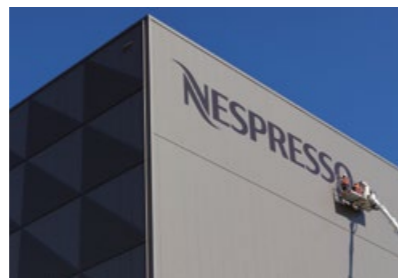

Nespresso · Romont, Switzerland

Conference center, Maakri · Tallin



Sipopo Congress Center · Malabo, Equatorial Guinea



Uffici Inail · Napoli, Italy



Nuova stazione Tiburtina · Roma, Italy Doha



Tiriac Tower Buzesti · Bucarest, Romania



SAMOA

Bank of Samoa H/O · Apia

SAUDI ARABIA

Faculty of Science College · Support Academic area · National Guard · Mobily offices · Argaam 3M Offices · Nat · Pfizer · Souq.com · Riyadh Bank · Deanary Building Imam University · ANB Bank · Riyadh · Transportation building · Qassim University Dental college · Qassim Bureda - Ksa · NT3 Naval base · Jeddah · Ksa · Girls college Al Khabji · Girls college Nariyah · Dammam University · Dammam · Ksa · Qassim University · Riyadh · Pfizer Offices · Jeddah

SERBIA

Municipality of Rakovica · Belgrade · FIAT · Kragujevac

SLOVAKIA

Aston Building head quarters · Offices Buiding · Kosice

SLOVENIA

Eda center · Nova Gorica

SPAIN

Instituto de Enseñanza les Reus · Tarragona International Airport · Valencia · New line 9 metro · Illacuna New Business Park · Design Center Library · Vopi · Barcellona Girona University · Girona · Campus Palmas Altas · Tecnology Park Palmas Altas · Sevilla Alei Center Office Complex · Malaga Maillorca Hospital · Maillorca · Banco Mare Nostrum (Bmn) Caixa Penedes · Corporate headquarters Expansion · Vilafranca

SWITZERLAND

CEJN Ag – Swiss headquarters · Cham · Nestlé E2V · La Tour-de-Peilz · Nespresso · Romont STG Creation Precigems · Satigny · UBS Rhône · Rolex Offices · Geneve

TUNISIA

Tunis Carthage International Airport Tunisiana · Orange · Tunisie Telecom · Siemens · STEG · Ekon · Carthage · Tav Aéroport Hammamet Enfidha · Aéroport de Monastir · Carrefour · Henkel · Total · Tunisi

TURKEY

Yildirimlar Holding · Akplaza Istanbul Municipality · Isbank New Head Quarter Çalık Holding Irak · Anadolu insurance headquarter · Yapı Kredi Plaza · Vodafone Tuzla Mtx Building · Tekfen · Levent Office Building · Tfbk Bank · Tophane Center

Management Building · Turkish Ground Forces · Yıldız Teknik Üniversitesi Davutpaşa Teknopark · Mercedes Benz · Bosch Termoteknik Genel Müdürlüğü · Simeks · Garanti Koza · Nt Headquarter · Opet Genel Müdürlüğü · Helis Metro Yapı · UTS Makine Kalıp Yönetim Binası · Doğuş Teknoloji; Kristal Kule · Tekstilbank Genel Müdürlüğü · Anadolu Sigorta Genel Müdürlüğü · Çalık Holding Iraq Borsa Istanbul Data Center · Metro Gross market · Vodafone · T.B.M.M. · Peugeot Genel Müdürlüğü · Herball Life · Vodafone Esenyurt Garanti Bankası · Eczacıbaşı · Tnt · Akfirat

Çalık Holding A.Ş. · University Of Economy · Izmir · Tekfen Office Building · Kağıthane Mercedes Benz · Bahcesehir · Aksaray / Hoşde-re Management Building · Doğuş İnşaat Ayazağa/Istanbul · Çalık Holding A.Ş. · Irak Power Plant · Bosch Çerkezköy · Garanti Bankası · Kredi Kartlar Birliği · Tübitak Uekae Yk Bank · Yapı Kredi Plaza/Banking Base · Clariant · Yapı Kredi Bankası · Atatürk Airport · Institute of Technology Turkcell · Gebze

UKRAINE

IQ Business Centre · Kiev



One Tower - One Floreasca City · Bucarest, Romania

Holding Building · Hurriyet Media · Maslak · Haci Omer Sabanci Holding · Ibm · Eczacibi Yıldız Tekno Park · Tskb Bank · Asja Bank · Avea Telecom · Garanti Koza · Koza Plaza Kutuk Mermer · Renault Bursa · Istanbul Turkcell Data Center · Beyoğlu · Akbank Departments (All over Türkiye) · Tskb Bank · Tophane Bepaş (İstikbal & Bellona) Garanti Bank Branch Over Turkey · Tnt Management Building · Ümraniye · Silkar Holding Building Bayrampaşa Zorlu Center · Eczacıbaşı · Levent Istanbul · Tfbk Bank · Kartal General Management · Yıldız Teknopark · Davutpaşa Campus · Vodafone TuzlaMtx Building · Yeşilköy Airport Tekyapi Tekyapi Vodafone Esenyurt Anel · Mtx Building Ergo · Hp · Ümraniye · Bosch · Çerkezköy Diem · Bsh – Kartal · Tekstil Bank Küçükalyi · Aktürk Zorlu Project · Levent · Tekfen · Kağıthane Building Yeni Teknik Yapı · Bosch General Management Building · Kare It Systems · Avea Güneşli · Dogan Engineering · Elaziğ Airport · Gürsel Transport · Kartal Management Building ·

UAE

Ruler's Court · Emitac Mobile Solutions Ilc · International City · Gate Village · Mercantile Exchange · Philip Morris · Dubai · National Chemicals Co Chemawajaat Offices · Company for Onshore Oil Operations · ADCO Offices · Abu Dhabi

UNITED KINGDOM

Queen Mary University · London

UNITED STATES

Memorial Hermann Hospital · Langham Creek YMCA · Federal Reserve Bank · Jacobs Engineering · Rice University Autry Courts · Ten West Corporate Center · Texas Children's Hospital West Campus · Memorial Hermann Medical Plaza · Houston Pavilions · Eldridge Green Office Building · Houston Baptist University · Weekley YMCA · Lake Houston YMCA · Houston

YEMEN

Public Telecommunication Corporation · Sanaa

Ogni attenzione è stata riservata alla compilazione di questi documenti prima della stampa.

Tuttavia, a causa della continua evoluzione tecnologica ed essendo costantemente impegnati sul fronte dello sviluppo e del miglioramento della nostra gamma di prodotti, ci riserviamo il diritto di modificare senza preavviso le relative specifiche tecniche.

Great care has been taken in the drafting of these document before going to print.

Nonetheless, owing to the continuous technological change and our ongoing commitment to develop and improve our range of products, we reserve the right to develop and improve our range of products and the right to modify the specifications of any product without prior notice.

Une attention particulière a été portée à la production de ces documents avant leur impression.

Cependant, en raison de l'évolution constante des technologies et étant nous-mêmes engagés dans le développement et l'amélioration de notre gamme de produits, nous nous réservons le droit de modifier les spécifications techniques de ceux-ci sans préavis.

Tutti i nostri prodotti sono realizzati in Italia.

All products are entirely made in Italy.

